



Nastri e accessori originali Lamiflex

Original Lamiflex flexible rapier tapes
and accessories

 **LAMIFLEX®**

ALTA TECNOLOGIA DEI COMPOSITI

Lamiflex

Un'azienda che ha contribuito a fare la storia della tessitura italiana ed internazionale

DIVERSIFICAZIONE DELLE TECNOLOGIE E DEI MERCATI DI RIFERIMENTO

UN SERVIZIO DEDICATO - TUTTO INTORNO AL CLIENTE

Lamiflex opera nel settore dei materiali compositi da più di 40 anni. Nasce nel 1976 dalla volontà imprenditoriale di Luigi Castelli e Luigina Bernini, titolari di un'azienda di produzioni tessili. Dalla necessità di aumentare la produttività dei telai, ebbero la lungimiranza di acquistare uno dei primi modelli a lance flessibili, l'unico al tempo in grado di soddisfare le sempre più esigenti necessità del mercato. Questi telai montavano nastri portapinzina in nylon, materiale che però aveva il limite di fondersi facilmente se usato ad alte velocità.

Da qui la volontà di studiare un nuovo tipo di nastro che fosse in grado di "tenere" la velocità del telaio. Nacque l'invenzione tecnologica che cambiò l'industria meccanotessile: il nastro in composito, realizzato dall'unione della struttura del cotone con la resina fenolica.

Il passo successivo, l'introduzione del poliestere con resina epossidica, permise a Lamiflex di aumentare in modo determinante la resistenza del nastro e la sua efficienza, migliorandone le performance.

L'esperienza acquisita e l'ormai profonda conoscenza dei compositi, portarono l'azienda ad inventare e brevettare il "nastro a rigidità variabile" e la "punta intercambiabile", entrambi know-how che, con il loro vantaggio competitivo, fecero presto di Lamiflex il leader di mercato in Italia e all'estero.

Lo straordinario successo del carbonio e delle sue infinite applicazioni, ha reso Lamiflex capace di offrire prodotti con un'eccezionale versatilità ed adattabilità, apprezzata dai progettisti di tutto il mondo.

Negli anni Lamiflex si dedica strategicamente a nuovi settori ed alla progettazione di nuove soluzioni applicative per soddisfare le esigenze dei clienti con una necessità esecutiva specifica. Qui risiede, insieme al know-how, la forza competitiva dell'azienda: la capacità di problem solving necessaria a trovare soluzioni innovative. Un team di ingegneri studia la fattibilità dei progetti, sviluppando la soluzione tecnica che il cliente ricerca, offrendo un servizio completo che comprende: fattibilità, design, prototipazione, produzione ed assistenza post-vendita.

Anche nelle Risorse Umane, Lamiflex è sempre stata attenta alla qualità delle persone ed alla loro formazione. Ingegneri dei materiali, ingegneri aeronautici e ingegneri chimici hanno le competenze specifiche da mettere in campo per occuparsi dei nuovi macchinari e dei nuovi progetti. Ad oggi, il 40% dei clienti Lamiflex è in Italia, il 35% in Europa ed il restante 25% opera nel resto del mondo, principalmente nei mercati di Asia, America e Turchia. I settori di appartenenza dei clienti sono: meccanotessile, industriale, medicale, aeronautico e dei rulli, in particolar modo destinati alla stampa flessografica, mentre il team di ingegneri Lamiflex si dedica ad un'incessante attività di ricerca per trovare nuove applicazioni in nuovi settori.

La solidità, la professionalità e la reputazione costruita negli anni permettono a Lamiflex di mantenere ed ampliare la sua leadership. Attraverso l'utilizzo delle tecnologie più evolute, come l'Impregnatrice a solvente, il Filament Winding, la Pultrusione e Pull-winding, il Wrapping, la Pressa a Passo e la Pressa Multivano, l'Autoclave, l'RTM e l'LPMC, l'azienda è in grado di fornire qualsiasi risposta attraverso processi produttivi integrati da sistemi informatici all'avanguardia.

Lamiflex, con le sue numerose famiglie di nastri, raggiunge da sempre gli alti standard richiesti dai clienti, coniugando un servizio puntuale ad una disponibilità di magazzino costante. Anche nella produzione di ruote dentate, strategico componente di ricambio nell'industria meccanotessile, Lamiflex è il partner ideale.

Un'eccellenza tutta italiana al servizio delle eccellenze di tutto il mondo.

DIVERSIFICATION OF TECHNOLOGIES AND MARKETS OF REFERENCE

A DEDICATED SERVICE – FOCUSED ON THE CUSTOMER

Lamiflex has been working in the sector of composite materials for over 40 years. The company was founded in 1976 as the result of the entrepreneurial determination of Luigi Castelli and Luigina Bernini, owners of a textile manufacturing company. Needing to increase the productivity of their looms, they had the foresight to purchase one of the first flexible rapier looms, the only one at the time able to satisfy the increasingly demanding needs of the market. These looms employed rapier tapes made of nylon, a material that easily melted if used at high speeds. This led to the need to design a new type of tape that was able to “withstand” the speed of the loom. A technological invention was unveiled that revolutionized the textile machinery industry: a composite tape, made by uniting cotton with phenolic resin.

The next step, the introduction of polyester with epoxy resin, allowed Lamiflex to significantly increase the strength of the tapes and their efficiency, thereby improving their performance.

The experience acquired and an in-depth knowledge of composites culminated in the company inventing and patenting the “tape with variable stiffness” and the “interchangeable tip”, both inventions that, with their competitive advantage, soon made Lamiflex a market leader in Italy and abroad.

The extraordinary success of carbon and its infinite applications allowed Lamiflex to offer products with exceptional versatility and adaptability that are appreciated by designers the world over.

Over the years, Lamiflex has strategically focused on new sectors and the design of new application solutions to satisfy customers with specific needs. Together with its know-how, this is where the company’s competitive strength lies: the ability to solve problems in order to find innovative solutions. A team of engineers studies the feasibility of the projects, developing the technical solution the customer is looking for and offering a complete service that includes: feasibility, design, prototyping, production and after-sales assistance.

Even with regard to human resources, Lamiflex has always focused on the quality of its staff and their training. Materials engineers, aeronautical engineers and chemical engineers have the specific skills required to develop new machinery and new projects.

Currently, 40% of Lamiflex’s customers are in Italy, 35% in Europe and the remaining 25% operate in the rest of the world, mainly in the markets of Asia, America and Turkey. The company’s customers are found in various sectors, including textile machinery, industrial, medical, aeronautical and rollers, particularly for flexo printing, while Lamiflex’s team of engineers is tirelessly devoted to research, with the aim of finding new applications in new sectors.

The stability, professionalism and reputation built over the years has allowed Lamiflex to maintain and expand its leadership. With the aid of the latest technology, such as the Solvent Impregnation, Filament Winding, Pultrusion and Pull-winding, Roll-wrapping, Progressive and Multi-chamber Press, Autoclave, RTM and LPMC, the company is able to provide any solution, developing production processes that are complemented by advanced IT systems.

Lamiflex, with its numerous types of tapes, has always succeeded in meeting the high standards requested by customers, combining a punctual service with continual warehouse availability. Lamiflex is also the ideal partner for the production of gear wheels, a strategic replacement part in the textile machinery industry.

An all-Italian company serving leading businesses around the world.

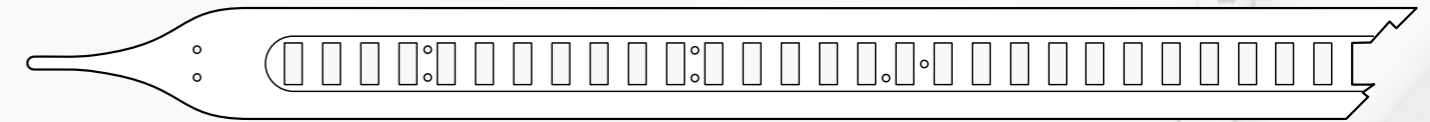

ART. N101	Telaio/Loom AC2/S TP1	Lungh. nastro Tape length	Codice Lamiflex Lamiflex Code	Variante Variant
DX/RIGHT	210	1900 mm	N101 1900	B Bianco - White type N Nero - Black type
	330	2450 mm	N101 2450	
	380	2700 mm	N101 2700	
	420	3100 mm	N101 3100	
	460	3400 mm	N101 3400	

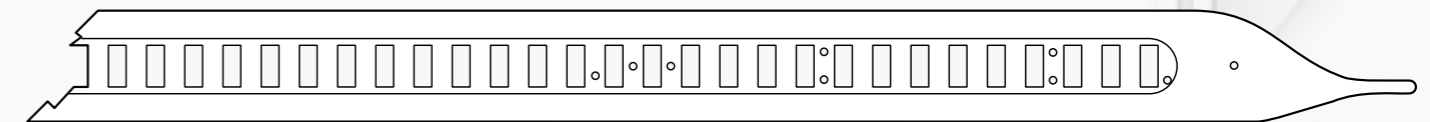

ART. N102	Telaio/Loom AC2/S TP1	Lungh. nastro Tape length	Codice Lamiflex Lamiflex Code	Variante Variant
SX/LEFT	210	1900 mm	N102 1900	B Bianco - White type N Nero - Black type
	330	2450 mm	N102 2450	
	380	2700 mm	N102 2700	
	420	3100 mm	N102 3100	
	460	3400 mm	N102 3400	

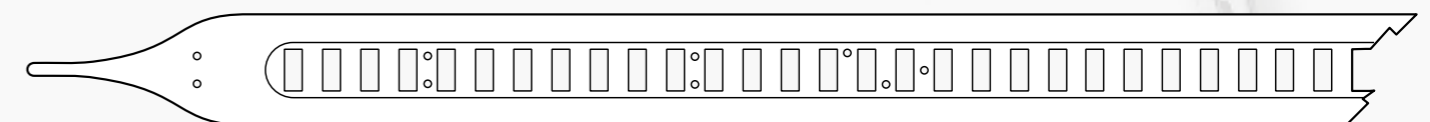

ART. N103	Telaio/Loom AC2/S TP2	Lungh. nastro Tape length	Codice Lamiflex Lamiflex Code	Variante Variant
DX/RIGHT	210	1900 mm	N103 1900	B Bianco - White type N Nero - Black type
	330	2450 mm	N103 2450	
	380	2700 mm	N103 2700	
	420	3100 mm	N103 3100	
	460	3400 mm	N103 3400	

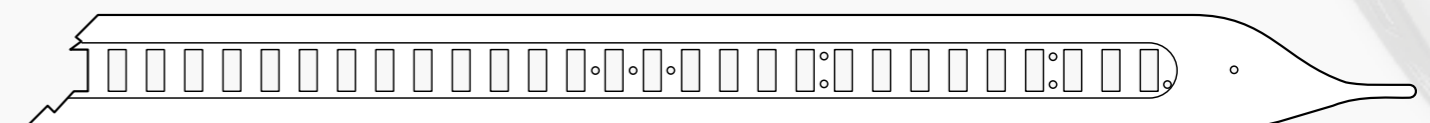

ART. N104	Telaio/Loom AC2/S TP2	Lungh. nastro Tape length	Codice Lamiflex Lamiflex Code	Variante Variant
SX/LEFT	210	1900 mm	N104 1900	B Bianco - White type N Nero - Black type
	330	2450 mm	N104 2450	
	380	2700 mm	N104 2700	
	420	3100 mm	N104 3100	
	460	3400 mm	N104 3400	

Nastri originali Lamiflex

Original Lamiflex flexible tapes

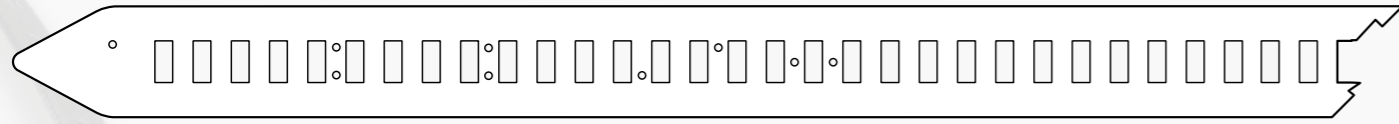

ART. N105	Telaio/Loom UV770	Lungh. nastro Tape length	Codice Lamiflex Lamiflex Code
DX-SX/RIGHT-LEFT	190	1920 mm	N105 1920
SPESSORE 2,5 mm THICKNESS 2,5 mm	210	2020 mm	N105 2020
	230	2120 mm	N105 2120
	260	2360 mm	N105 2360
	300	2560 mm	N105 2560
	340	2760 mm	N105 2760
	360	2880 mm	N105 2880

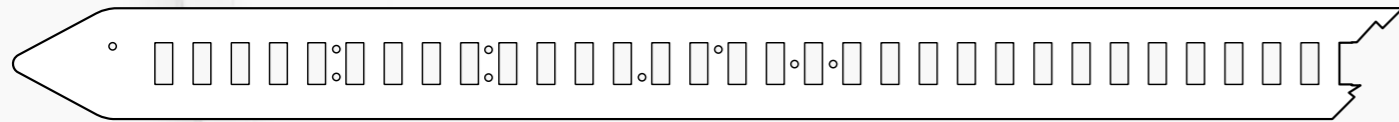

ART. N106	Telaio/Loom UV770	Lungh. nastro Tape length	Codice Lamiflex Lamiflex Code
DX-SX/RIGHT-LEFT	190	1690 mm	N106 1690
SPESSORE 3 mm THICKNESS 3 mm	210	1790 mm	N106 1790
	230	1890 mm	N106 1890
	260	2130 mm	N106 2130
	300	2330 mm	N106 2330
	340	2530 mm	N106 2530
	360	2650 mm	N106 2650

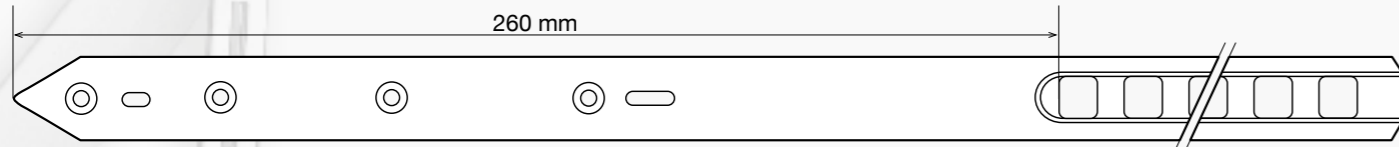

ART. N107	Telaio/Loom THEMA 11	Lungh. nastro Tape length	Codice Lamiflex Lamiflex Code	Variante Variant	
DX-SX/RIGHT-LEFT	165	2056 mm	N107 2056	C Per cotone - For cotton	
	190	2187 mm	N107 2187		
	210	2287 mm	N107 2287		
	220	2330 mm	N107 2330		
	230	2385 mm	N107 2385		
	260	2593 mm	N107 2593		
	280	2692 mm	N107 2692		
	300	2791 mm	N107 2791		
	320	2890 mm	N107 2890		S Per seta - For silk
	340	2988 mm	N107 2988		
	360	3098 mm	N107 3098		
	380	3197 mm	N107 3197		
400	3295 mm	N107 3295			

Nastri originali Lamiflex

Original Lamiflex flexible tapes



ART. N107 B	Telaio/Loom ALPHA GFG	Lungh. nastro Tape length	Codice Lamiflex Lamiflex Code	Variante Variant
DX-SX/RIGHT-LEFT	170	2175 mm	N107B 2175	C Per cotone - For cotton
	190	2258 mm	N107B 2258	
	210	2357 mm	N107B 2357	
	220	2398 mm	N107B 2398	
	230	2456 mm	N107B 2456	
	260	2663 mm	N107B 2663	
	280	2763 mm	N107B 2763	
	300	2862 mm	N107B 2862	
	320	2961 mm	N107B 2961	
	340	3060 mm	N107B 3060	
	360	3168 mm	N107B 3168	
	380	3267 mm	N107B 3267	
	400	3367 mm	N107B 3367	
	420	3466 mm	N107B 3466	
	460	3665 mm	N107B 3665	

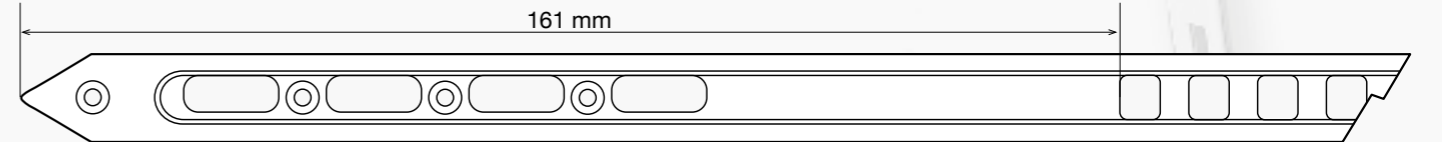

ART. N108
DX-SX/RIGHT-LEFT

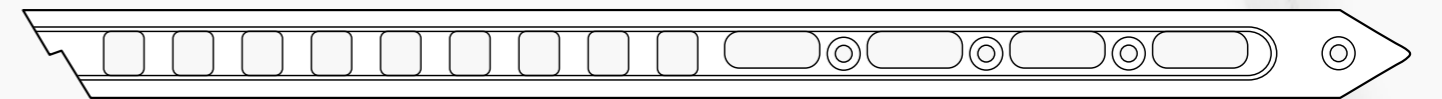

ART. N850	Telaio/Loom MASTER SM92-SM93	Lungh. nastro Tape length	Codice Lamiflex Lamiflex Code	Variante Variant	
DX-SX/RIGHT-LEFT	165	1891 mm	N108 1891 N850 1891	C Per cotone For cotton	
	190	2001 mm	N108 2001 N850 2001		
	210-220	2155 mm	N108 2155 N850 2155		
	230	2199 mm	N108 2199 N850 2199		
	260	2418 mm	N108 2418 N850 2418		
	280	2528 mm	N108 2528 N850 2528		
	320	2725 mm	N108 2725 N850 2725		
	340	2813 mm	N108 2813 N850 2813		S Per seta For silk
	360	2923 mm	N108 2923 N850 2923		
	380	3021 mm	N108 3021 N850 3021		
	420	3218 mm	N108 3218 N850 3218		
	460	3406 mm	N108 3406 N850 3406		

Nastri originali Lamiflex

Original Lamiflex flexible tapes

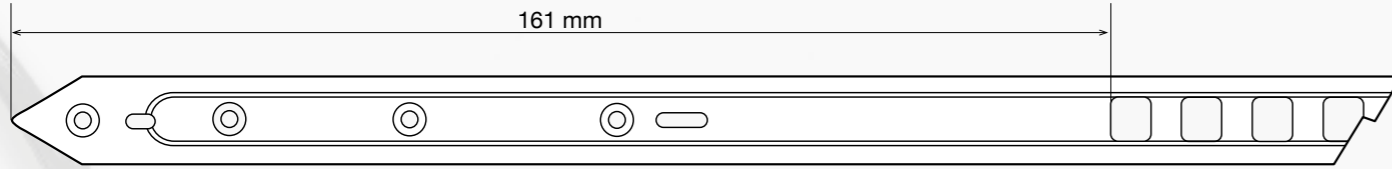

ART. N109	Telaio/Loom MASTER SM92-SM93	Lungh. nastro Tape length	Codice Lamiflex Lamiflex Code	Variante Variant
DX-SX/RIGHT-LEFT				
PER PINZA THEMA FOR THEMA GRIPPER	165	1892 mm	N109 1892	C Per cotone - For cotton
	190	2000 mm	N109 2000	
	210	2154 mm	N109 2154	
	230	2198 mm	N109 2198	
	260	2417 mm	N109 2417	
	280	2527 mm	N109 2527	
	320	2724 mm	N109 2724	
	340	2812 mm	N109 2812	S Per seta - For silk
	360	2922 mm	N109 2922	
	380	3020 mm	N109 3020	
	420	3219 mm	N109 3219	
	460	3405 mm	N109 3405	

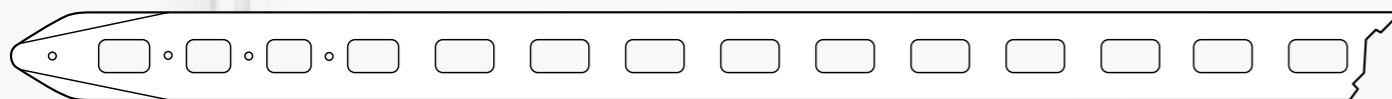

ART. N110	Telaio/Loom ST880	Lungh. nastro Tape length	Codice Lamiflex Lamiflex Code
DX-SX/RIGHT-LEFT			
	190	1956 mm	N110 1956
	220	2044 mm	N110 2044
	230	2154 mm	N110 2154
	260	2395 mm	N110 2395
	310	2593 mm	N110 2593
	340	2790 mm	N110 2790
	360	2900 mm	N110 2900

Nastri originali Lamiflex

Original Lamiflex flexible tapes

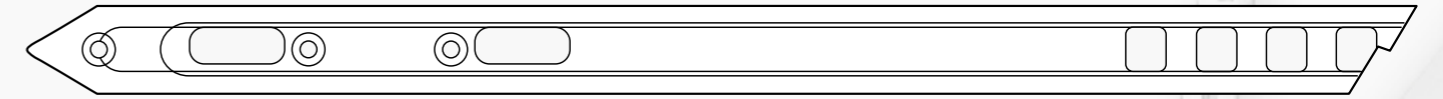

ART. N111	Telaio/Loom THEMA	Lungh. nastro Tape length	Codice Lamiflex Lamiflex Code	Variante Variant
DX-SX/RIGHT-LEFT				
	165	2099 mm	N111 2099	C Per cotone - For cotton
	190	2209 mm	N111 2209	
	210-220	2362 mm	N111 2362	
	230	2418 mm	N111 2418	
	260	2626 mm	N111 2626	
	280	2725 mm	N111 2725	
	300-320	2923 mm	N111 2923	
	340	3021 mm	N111 3021	S Per seta - For silk
	360	3130 mm	N111 3130	
	380	3218 mm	N111 3218	
	400	3406 mm	N111 3406	
	420	3525 mm	N111 3525	
	460	3745 mm	N111 3745	

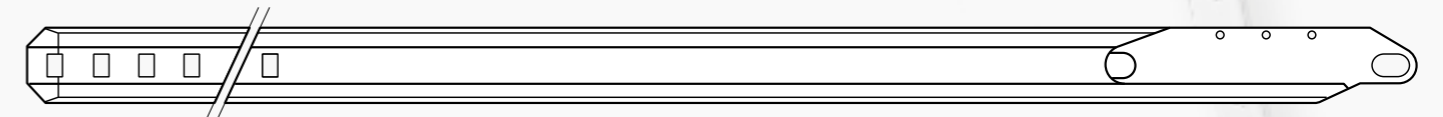

ART. N112	Telaio/Loom EXCEL/MFG	Lungh. nastro Tape length	Codice Lamiflex Lamiflex Code
SX/LEFT			
	165	1980 mm	N112 1980
	190	2104 mm	N112 2104
	210	2203 mm	N112 2203
	220	2253 mm	N112 2253
	230	2303 mm	N112 2303
	260	2517 mm	N112 2517
	280	2616 mm	N112 2616
	300	2715 mm	N112 2715
	320	2814 mm	N112 2814
	340	2913 mm	N112 2913
	360	3012 mm	N112 3012
	380	3119 mm	N112 3119
	400	3218 mm	N112 3218

Nastri originali Lamiflex

Original Lamiflex flexible tapes

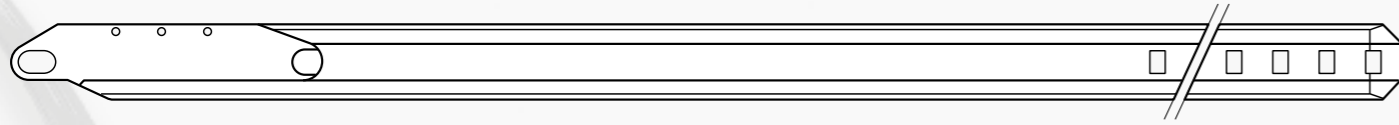

ART. N113	Telaio/Loom EXCEL/MFG	Lungh. nastro Tape length	Codice Lamiflex Lamiflex Code
DX/RIGHT	165	1980 mm	N113 1980
	190	2104 mm	N113 2104
	210	2203 mm	N113 2203
	220	2253 mm	N113 2253
	230	2303 mm	N113 2303
	260	2517 mm	N113 2517
	280	2616 mm	N113 2616
	300	2715 mm	N113 2715
	320	2814 mm	N113 2814
	340	2913 mm	N113 2913
	360	3012 mm	N113 3012
	380	3119 mm	N113 3119
	400	3218 mm	N113 3218

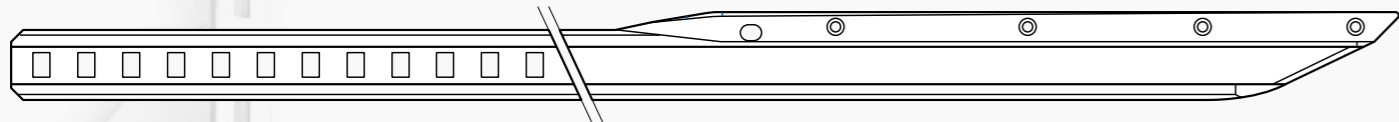

ART. N117	Telaio/Loom EXCEL/MFG	Lungh. nastro Tape length	Codice Lamiflex Lamiflex Code
SX/LEFT	132	1964 mm	N117 1964
PORTANTE	165	2128 mm	N117 2128
	190	2252 mm	N117 2252
	210	2351 mm	N117 2351
	220	2400 mm	N117 2400
	230	2450 mm	N117 2450
	260	2664 mm	N117 2664
	280	2763 mm	N117 2763
	300	2862 mm	N117 2862
	320	2961 mm	N117 2961
	340	3060 mm	N117 3060
	360	3159 mm	N117 3159
	380	3267 mm	N117 3267
	400	3366 mm	N117 3366

Nastri originali Lamiflex

Original Lamiflex flexible tapes

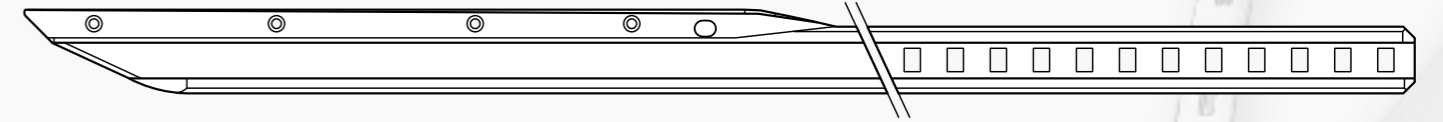

ART. N118	Telaio/Loom EXCEL/MFG	Lungh. nastro Tape length	Codice Lamiflex Lamiflex Code
DX/RIGHT	132	1964 mm	N118 1964
TRAENTE	165	2128 mm	N118 2128
	190	2252 mm	N118 2252
	210	2351 mm	N118 2351
	220	2400 mm	N118 2400
	230	2450 mm	N118 2450
	260	2664 mm	N118 2664
	280	2763 mm	N118 2763
	300	2862 mm	N118 2862
	320	2961 mm	N118 2961
	340	3060 mm	N118 3060
	360	3159 mm	N118 3159
	380	3267 mm	N118 3267
	400	3366 mm	N118 3366

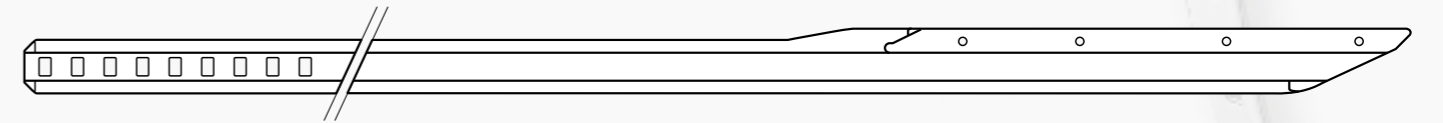

ART. N120	Telaio/Loom ALPHA/MFG	Lungh. nastro Tape length	Codice Lamiflex Lamiflex Code	Variante Variant
SX/LEFT	170	2285 mm	N120 2285	C Per cotone - For cotton
	190	2360 mm	N120 2360	
	210	2459 mm	N120 2459	
	220	2508 mm	N120 2508	
	230	2558 mm	N120 2558	
	260	2772 mm	N120 2772	
	280	2871 mm	N120 2871	
	300	2970 mm	N120 2970	
	320	3069 mm	N120 3069	
	340	3168 mm	N120 3168	
	360	3267 mm	N120 3267	
	380	3374 mm	N120 3374	
	400	3473 mm	N120 3473	
	420	3671 mm	N120 3671	
	460	4076 mm	N120 4076	

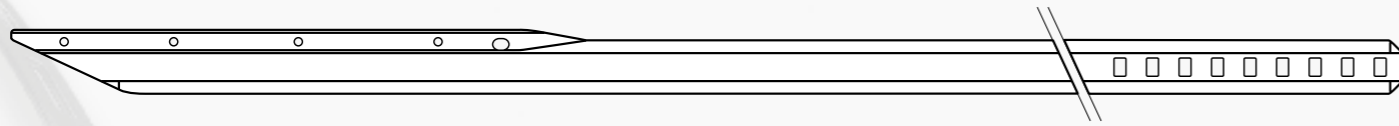

ART. N121	Telaio/Loom ALPHA/MFG	Lungh. nastro Tape length	Codice Lamiflex Lamiflex Code	Variante Variant
DX/RIGHT	170	2285 mm	N121 2285	C Per cotone - For cotton
	190	2360 mm	N121 2360	
	210	2459 mm	N121 2459	
	220	2508 mm	N121 2508	
	230	2558 mm	N121 2558	
	260	2772 mm	N121 2772	
	280	2871 mm	N121 2871	
	300	2970 mm	N121 2970	
	320	3069 mm	N121 3069	
	340	3168 mm	N121 3168	
	360	3267 mm	N121 3267	
	380	3374 mm	N121 3374	
	400	3473 mm	N121 3473	
	420	3671 mm	N121 3671	
	460	4076 mm	N121 4076	

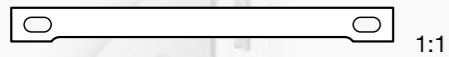

ART. P112
CINGHIETTA/SPRING

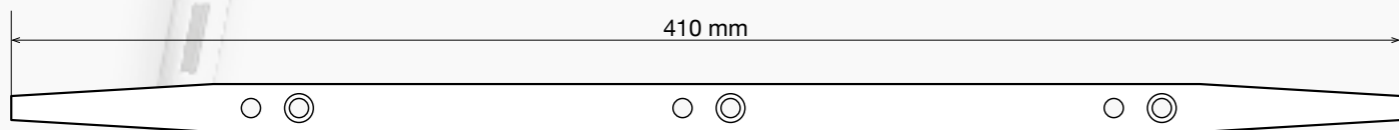

ART. P113
PATTINO APPROPINZA/OPENER BLADE

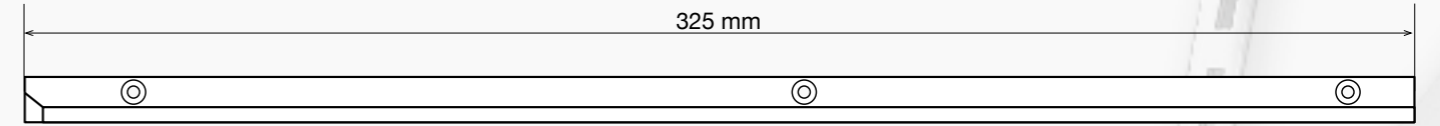

ART. P114
PATTINO DI RISCONTRO/OPENER BLADE



ART. P119 TR 3,80 CA E CCT
PROTEZIONE TRAENTE - DX/GRIPPER PROTECTION - RIGHT



ART. P119 PT 3,80 CA E CCT
PROTEZIONE PORTANTE - SX/GRIPPER PROTECTION - LEFT

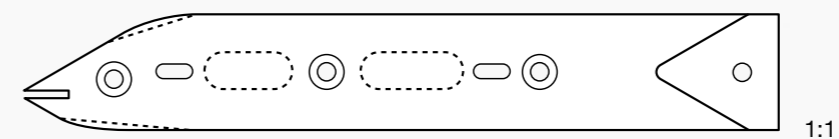

ART. P121 0106 FN
PROTEZIONE PER TRAENTE - DX/POINT PROTECTION - RIGHT



ART. P121 0126 FN

PROTEZIONE PER TRAEUTE - DX/POINT PROTECTION - RIGHT

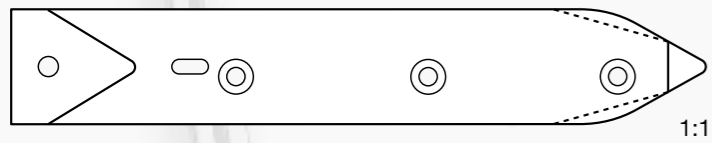

ART. P121 0097 FN

PROTEZIONE PER PORTANTE - SX/POINT PROTECTION - LEFT

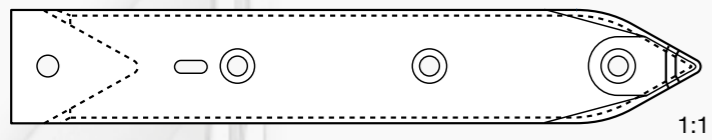

ART. P121 0097 T1

PROTEZIONE PER PORTANTE - SX/POINT PROTECTION - LEFT

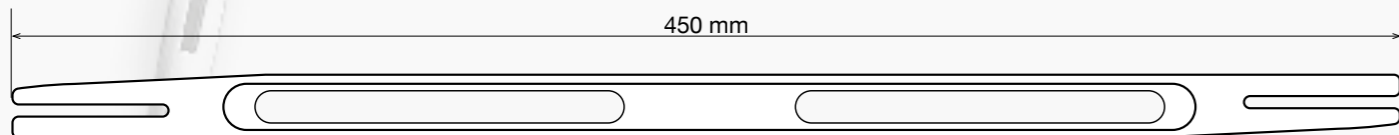

ART. P125

PATTINO APRIPINZA/OPENER BLADE

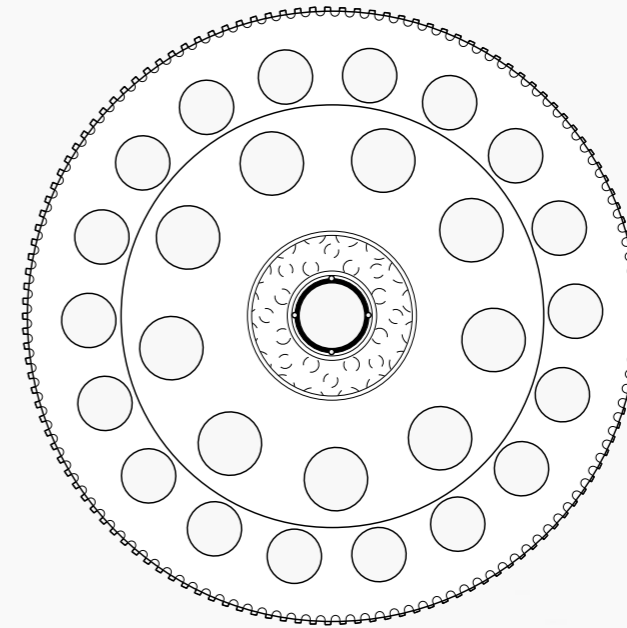

ART. R001A#129 &

RUOTA DENTATA PER NASTRI TIPO EXCEL/TOOTHED WHEEL FOR EXCEL TYPE TAPES

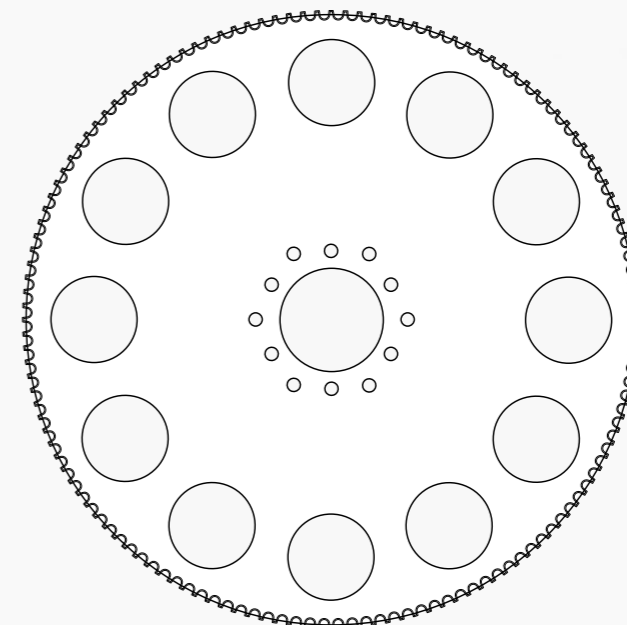

ART. R024A#136 M

RUOTA DENTATA PER NASTRI TIPO LEONARDO-ALPHA/TOOTHED WHEEL FOR LEONARDO-ALPHA TYPE TAPES

Particolari originali Lamiflex

Original Lamiflex accessories

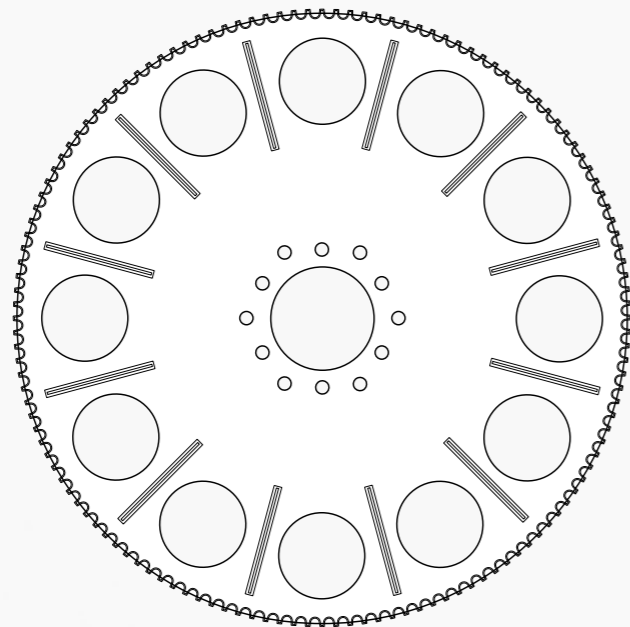

ART. R025A#136 M

RUOTA DENTATA PER NASTRI TIPO LEONARDO-ALPHA/TOOTHED WHEEL FOR LEONARDO-ALPHA TYPE TAPES

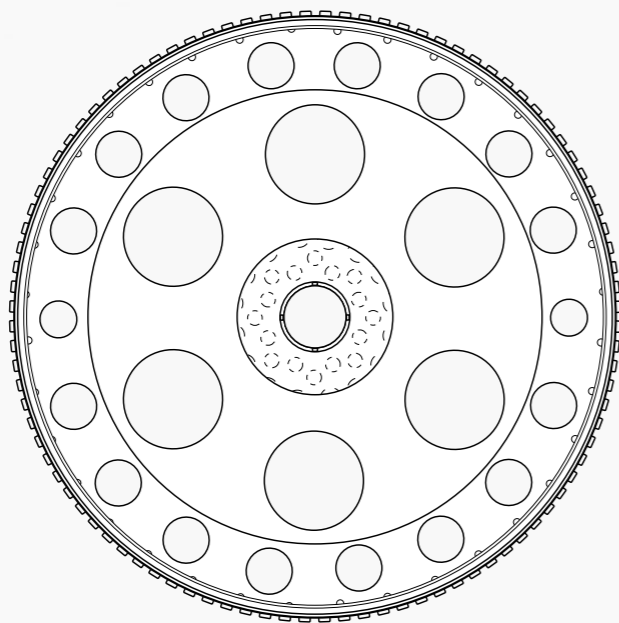

ART. R011#96 T1 &

RUOTA DENTATA PER NASTRI TIPO THEMA E MASTER/TOOTHED WHEEL FOR THEMA AND MASTER TYPE TAPES

Nastri originali Lamiflex

Original Lamiflex flexible tapes

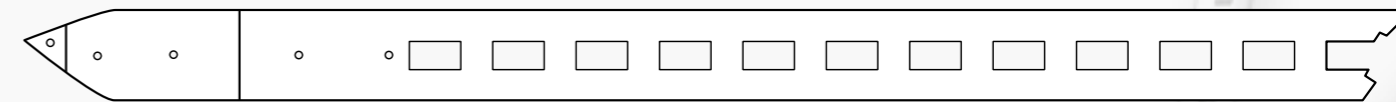

ART. N202	Telaio/Loom C 301-C 401	Lungh. nastro Tape length	Codice Lamiflex Lamiflex Code	Variante Variant
DX-SX/RIGHT-LEFT	160	1780 mm	N202 1780	C Per cotone - For cotton
	190	1920 mm	N202 1920	
	210	2015 mm	N202 2015	
	230	2110 mm	N202 2110	
	260	2275 mm	N202 2275	S Per seta - For silk
	300	2515 mm	N202 2515	
	320	2610 mm	N202 2610	
	340	2705 mm	N202 2705	
	360	2800 mm	N202 2800	
	380	2895 mm	N202 2895	

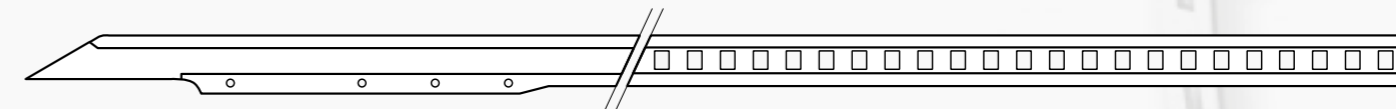

ART. N203	Telaio/Loom P1001	Lungh. nastro Tape length	Codice Lamiflex Lamiflex Code	Variante Variant
DX/RIGHT	1600	2030 mm	N203 2030	C Per cotone - For cotton
	1900	2180 mm	N203 2180	
	2100	2280 mm	N203 2280	
	2300	2380 mm	N203 2380	
	2600	2530 mm	N203 2530	S Per seta - For silk
	3000	2760 mm	N203 2760	
	3200	2860 mm	N203 2860	
	3400	2960 mm	N203 2960	
CON PUNTA IN CARBONIO WITH CARBON POINT	3600	3060 mm	N203 3060	
	3800	3160 mm	N203 3160	



ART. N204	Telaio/Loom P1001	Lungh. nastro Tape length	Codice Lamiflex Lamiflex Code	Variante Variant
SX/LEFT	1600	2190 mm	N204 2190	C Per cotone - For cotton
	1900	2340 mm	N204 2340	
	2100	2440 mm	N204 2440	
	2300	2540 mm	N204 2540	
	2600	2690 mm	N204 2690	S Per seta - For silk
	3000	2920 mm	N204 2920	
	3200	3020 mm	N204 3020	
	3400	3120 mm	N204 3120	
CON PUNTA IN CARBONIO WITH CARBON POINT	3600	3220 mm	N204 3220	
	3800	3320 mm	N204 3320	

Nastri originali Lamiflex

Original Lamiflex flexible tapes

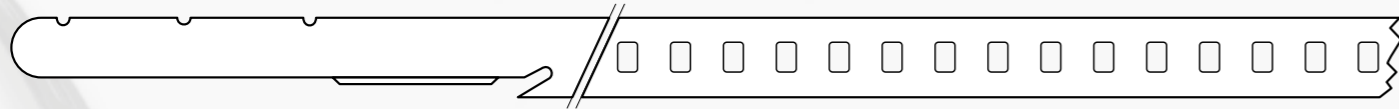

ART. N205	Telaio/Loom P1001	Lungh. nastro Tape length	Codice Lamiflex Lamiflex Code
DX/RIGHT	160	1945 mm	N205 1945
CON PUNTA INTERCAMBIABILE WITH CHANGEABLE POINT	190	2095 mm	N205 2095
	210	2195 mm	N205 2195
	230	2295 mm	N205 2295
	260	2445 mm	N205 2445
	280	2545 mm	N205 2545
	300	2675 mm	N205 2675
	320	2775 mm	N205 2775
	340	2875 mm	N205 2875
	360	2975 mm	N205 2975
	380	3075 mm	N205 3075

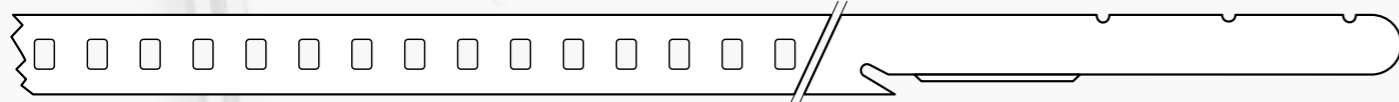

ART. N206	Telaio/Loom P1001	Lungh. nastro Tape length	Codice Lamiflex Lamiflex Code
SX/LEFT	160	2130 mm	N206 2130
CON PUNTA INTERCAMBIABILE WITH CHANGEABLE POINT	190	2280 mm	N206 2280
	210	2380 mm	N206 2380
	230	2480 mm	N206 2480
	260	2630 mm	N206 2630
	280	2730 mm	N206 2730
	300	2860 mm	N206 2860
	320	2960 mm	N206 2960
	340	3060 mm	N206 3060
	360	3160 mm	N206 3160
	380	3260 mm	N206 3260



ART. N207	Telaio/Loom 9000 PLUS	Lungh. nastro Tape length	Codice Lamiflex Lamiflex Code	Variante Variant
DX-SX/RIGHT-LEFT	190	2450 mm	N207 2450	C Per cotone - For cotton S Per seta - For silk
SPESSORE 3 mm THICKNESS 3 mm	210	2550 mm	N207 2550	
	230	2650 mm	N207 2650	
	260	2800 mm	N207 2800	
	280	2900 mm	N207 2900	
	300	3030 mm	N207 3030	
	320	3130 mm	N207 3130	
	340	3230 mm	N207 3230	
	360	3330 mm	N207 3330	
380	3430 mm	N207 3430		
CON PUNTA IN CARBONIO WITH CARBON POINT				

Nastri originali Lamiflex

Original Lamiflex flexible tapes

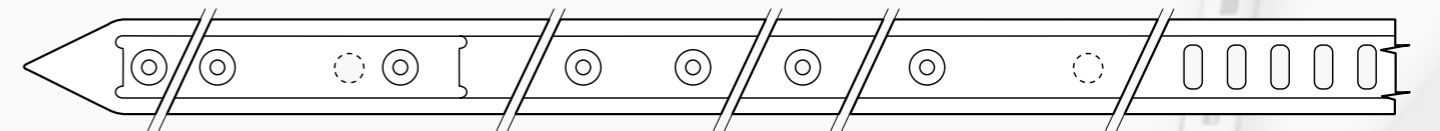

ART. N208	Telaio/Loom 9000 PLUS	Lungh. nastro Tape length	Codice Lamiflex Lamiflex Code
DX-SX/RIGHT-LEFT	190	2450 mm	N208 2450
SPESSORE 4 mm THICKNESS 4 mm	210	2550 mm	N208 2550
	230	2650 mm	N208 2650
	260	2800 mm	N208 2800
	280	2900 mm	N208 2900
	300	3030 mm	N208 3030
	320	3130 mm	N208 3130
	340	3230 mm	N208 3230
	360	3330 mm	N208 3330
	380	3430 mm	N208 3430

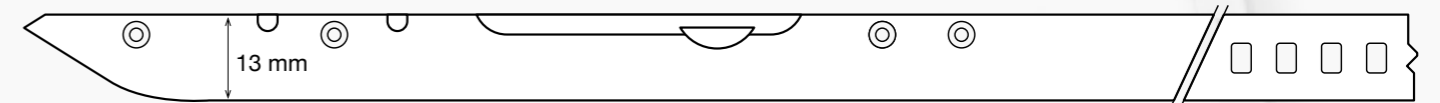

ART. N209	Telaio/Loom LEONARDO	Lungh. nastro Tape length	Codice Lamiflex Lamiflex Code	Variante Variant
DX/RIGHT	170	2140 mm	N209 2140	C Per cotone - For cotton
	190	2240 mm	N209 2240	
	210	2340 mm	N209 2340	
	220	2390 mm	N209 2390	
	230	2440 mm	N209 2440	
	260	2590 mm	N209 2590	
	280	2690 mm	N209 2690	
	300	2820 mm	N209 2820	
	320	2920 mm	N209 2920	
	340	3020 mm	N209 3020	
	360	3120 mm	N209 3120	
	380	3220 mm	N209 3220	S Per seta - For silk

Nastri originali Lamiflex

Original Lamiflex flexible tapes

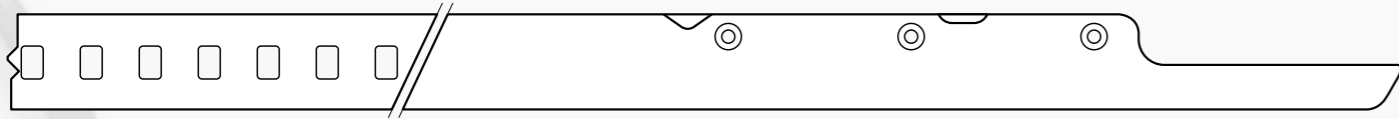

ART. N210	Telaio/Loom LEONARDO	Lungh. nastro Tape length	Codice Lamiflex Lamiflex Code	Variante Variant
SX/LEFT	170	2230 mm	N210 2230	C Per cotone - For cotton
	190	2330 mm	N210 2330	
	210	2430 mm	N210 2430	
	220	2480 mm	N210 2480	
	230	2530 mm	N210 2530	
	260	2680 mm	N210 2680	
	280	2780 mm	N210 2780	
	300	2910 mm	N210 2910	
	320	3010 mm	N210 3010	S Per seta - For silk
	340	3110 mm	N210 3110	
	360	3210 mm	N210 3210	
	380	3310 mm	N210 3310	

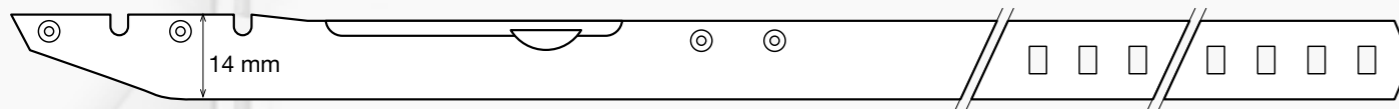

ART. N212	Telaio/Loom LEONARDO	Lungh. nastro Tape length	Codice Lamiflex Lamiflex Code	Variante Variant
DX/RIGHT	170	2122 mm	N212 2122	C Per cotone - For cotton
	190	2222 mm	N212 2222	
	210	2322 mm	N212 2322	
	220	2372 mm	N212 2372	
	230	2422 mm	N212 2422	
	260	2572 mm	N212 2572	
	280	2672 mm	N212 2672	
	300	2802 mm	N212 2802	
	320	2902 mm	N212 2902	S Per seta - For silk
	340	3002 mm	N212 3002	
	360	3102 mm	N212 3102	
	380	3202 mm	N212 3202	

Nastri originali Lamiflex

Original Lamiflex flexible tapes

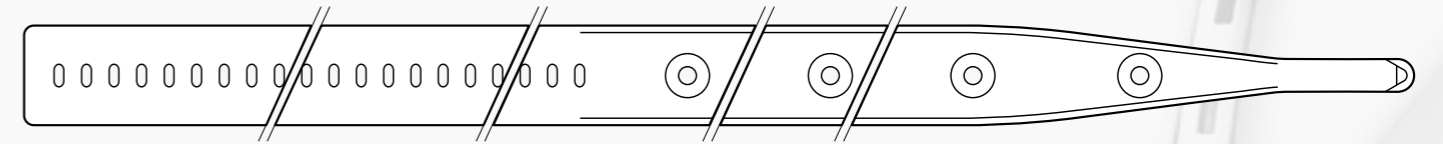

ART. N216	Telaio/Loom LEONARDO FTS	Lungh. nastro Tape length	Codice Lamiflex Lamiflex Code
SX/LEFT	170	2275 mm	N216 2275
	190	2375 mm	N216 2375
	210	2475 mm	N216 2475
	220	2525 mm	N216 2525
	230	2575 mm	N216 2575
	260	2725 mm	N216 2725
	280	2825 mm	N216 2825
	300	2955 mm	N216 2955
	320	3055 mm	N216 3055
	340	3155 mm	N216 3155
	360	3255 mm	N216 3255

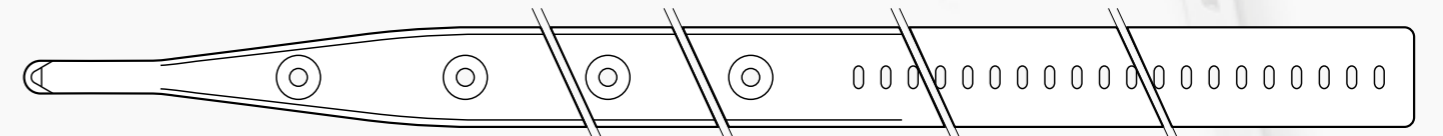

ART. N217	Telaio/Loom LEONARDO FTS	Lungh. nastro Tape length	Codice Lamiflex Lamiflex Code
DX/RIGHT	170	2065 mm	N217 2065
	190	2165 mm	N217 2165
	210	2265 mm	N217 2265
	220	2315 mm	N217 2315
	230	2365 mm	N217 2365
	260	2515 mm	N217 2515
	280	2615 mm	N217 2615
	300	2745 mm	N217 2745
	320	2845 mm	N217 2845
	340	2945 mm	N217 2945
	360	3045 mm	N217 3045

Nastri originali Lamiflex

Original Lamiflex flexible tapes

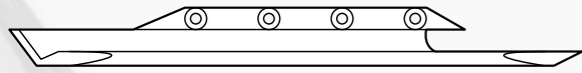

PUNTA SINISTRA
LEFT POINT
PT

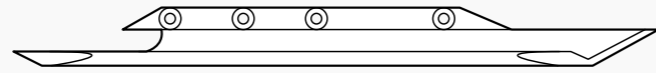

PUNTA DESTRA
RIGHT POINT
TR

ART. P211 PT/TR

PUNTE - SPESSORE 4/6,5 mm/POINTS - THICKNESS 4/6,5 mm

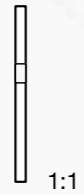
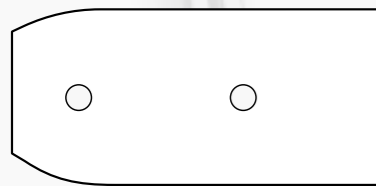

1:1

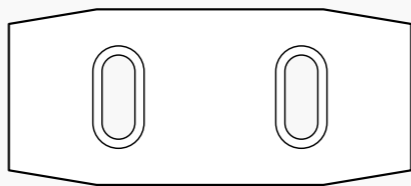

1:1

ART. P212

PIASTRINA PER PUNTA NASTRO
POINT PROTECTION

ART. P213

PIASTRINA DI REAZIONE
OPENER BLADE

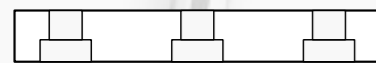
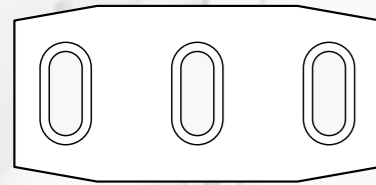

1:1

ART. P216

PIASTRINA DI REAZIONE
OPENER BLADE

Particolari originali Lamiflex

Original Lamiflex accessories

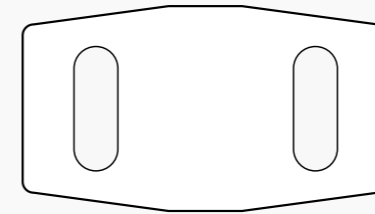

1:1

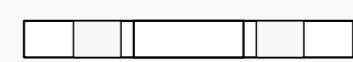
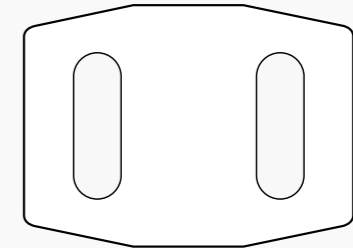

1:1

ART. P217

PIASTRINA DI APERTURA
OPENER BLADE

ART. P218

PIASTRINA DI APERTURA PINZA PORTANTE
OPENER BLADE

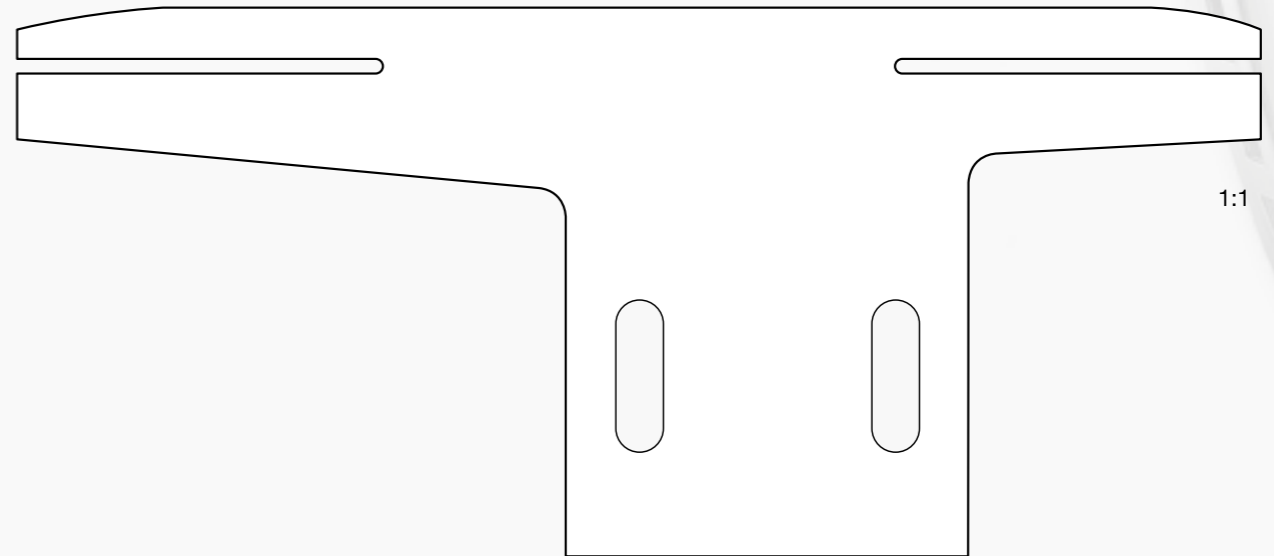

1:1

ART. P220

PIASTRINA APRIPINZA/OPENER BLADE

Nastri originali Lamiflex

Original Lamiflex flexible tapes

Particolari originali Lamiflex

Original Lamiflex accessories

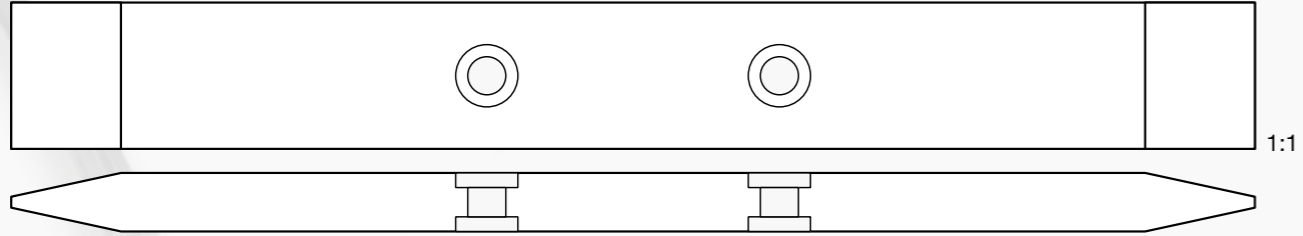

ART. P219

PIASTRINA APRIPINZA TRAENTE/OPENER BLADE

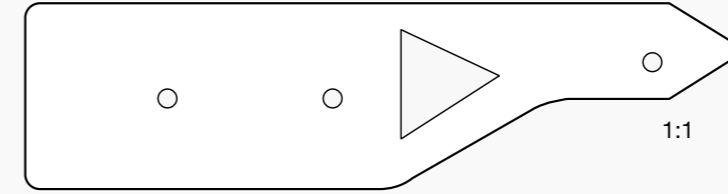

ART. P240

PIASTRINA PER PUNTA NASTRO/POINT PROTECTION

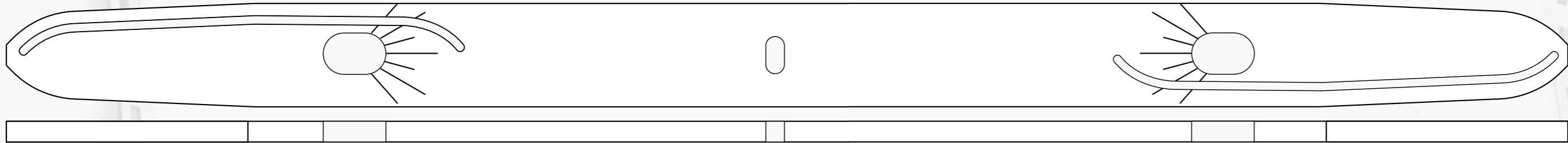

ART. P223

PIASTRA APRIPINZA/OPENER BLADE

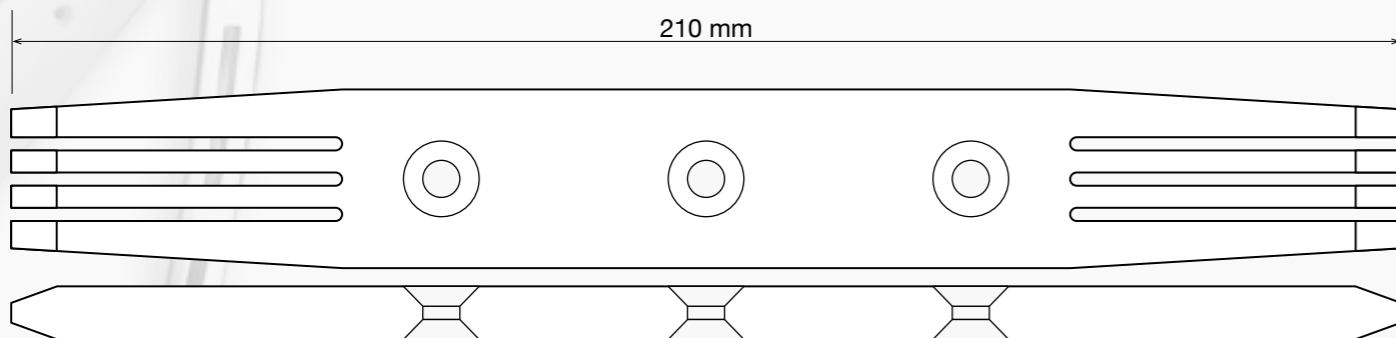

ART. P224

PIASTRINA APRIPINZA TRAENTE/OPENER BLADE

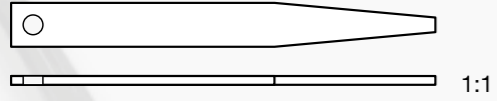

ART. P226
LAMINA DI PRESSIONE SUPERIORE/UPPER BLADE

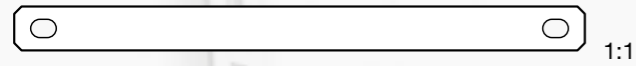

ART. P231
LAMINA DI TRAZIONE/OPENER SPRING



ART. P225
LAMINA DI PRESSIONE INFERIORE/LOWER BLADE

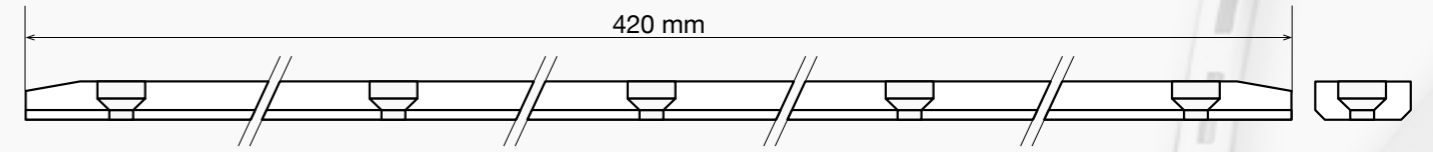

ART. P227
PIATTO DI REAZIONE/SUPPORT BAR

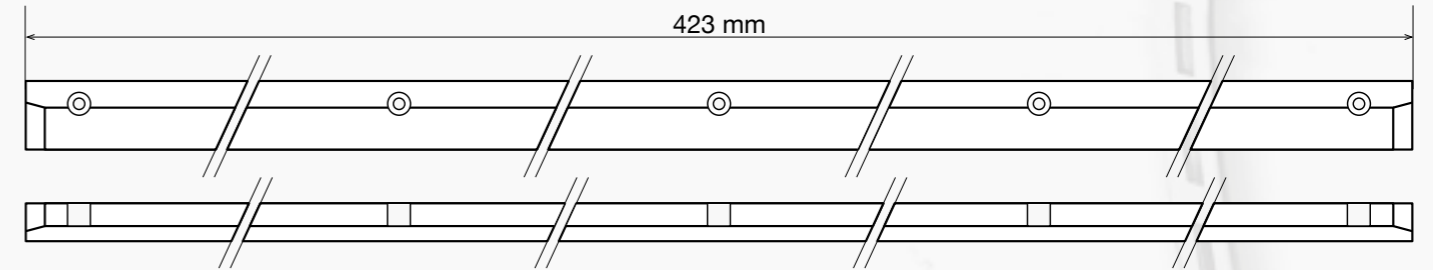

ART. P229
REAZIONE PER PINZA/GRIPPER SUPPORT

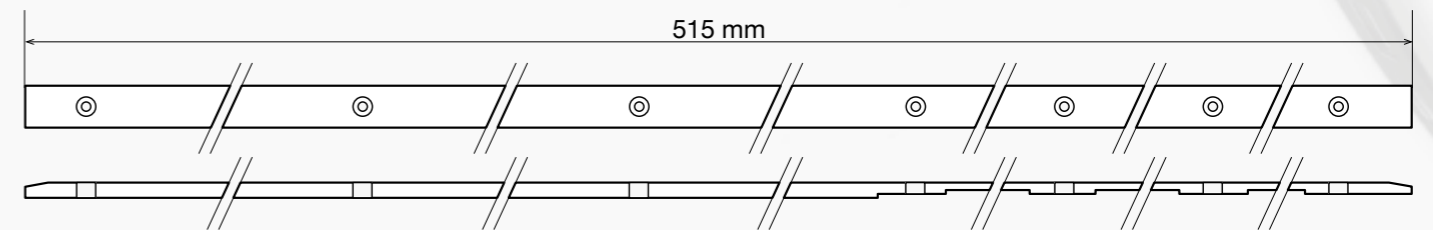

ART. P230
PIATTO DI SOSTEGNO/SUPPORT BAR

Nastri originali Lamiflex

Original Lamiflex flexible tapes

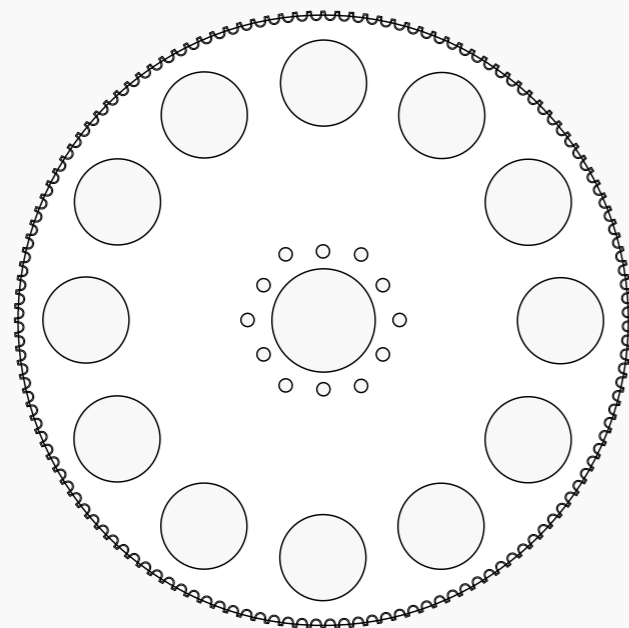

ART. R024A#136 M

RUOTA DENTATA PER NASTRI TIPO LEONARDO-ALPHA/TOOTHED WHEEL FOR LEONARDO-ALPHA TYPE TAPES

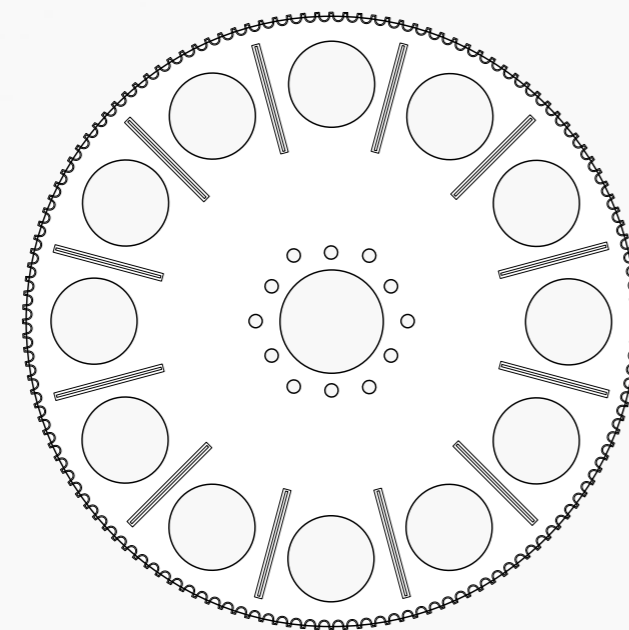

ART. R025A#136 M

RUOTA DENTATA PER NASTRI TIPO LEONARDO-ALPHA/TOOTHED WHEEL FOR LEONARDO-ALPHA TYPE TAPES

Nastri originali Lamiflex

Original Lamiflex flexible tapes

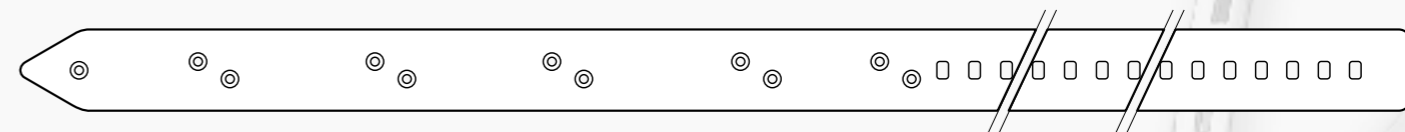

ART. N301	Telaio/Loom GTM	Lungh. nastro Tape length	Codice Lamiflex Lamiflex Code	Variante Variant
DX/RIGHT	190	2161 mm	N301 2161	CC Con carbonio - With carbon
	220-240	2631 mm	N301 2631	SC Senza carbonio - Without carbon
	280	2948 mm	N301 2948a	

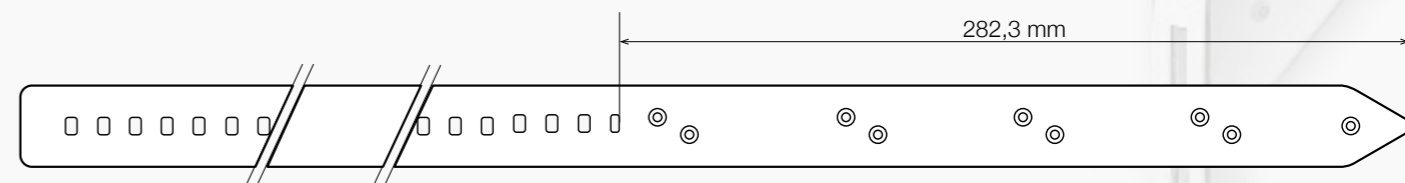

ART. N302	Telaio/Loom GTM	Lungh. nastro Tape length	Codice Lamiflex Lamiflex Code	Variante Variant
SX/LEFT	190	2174 mm	N302 2174	CC Con carbonio - With carbon
	220-240	2631 mm	N302 2631	SC Senza carbonio - Without carbon
	280	2961 mm	N302 2961	

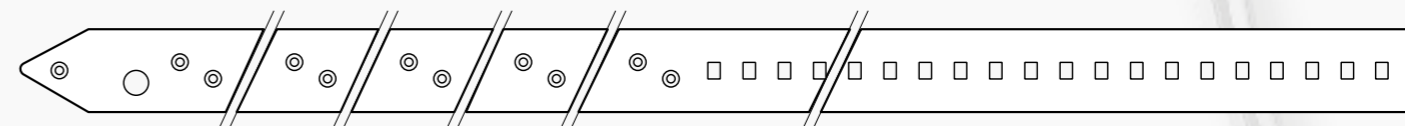

ART. N303	Telaio/Loom GTM	Lungh. nastro Tape length	Codice Lamiflex Lamiflex Code	Variante Variant
DX/RIGHT	190	2161 mm	N303 2161	CC Con carbonio - With carbon
	220-240	2631 mm	N303 2631	SC Senza carbonio - Without carbon
	280	2948 mm	N303 2948	

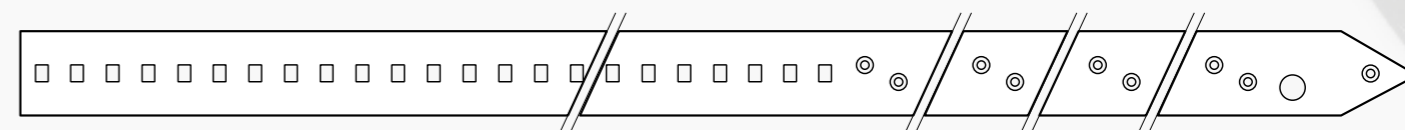

ART. N304	Telaio/Loom GTM	Lungh. nastro Tape length	Codice Lamiflex Lamiflex Code	Variante Variant
SX/LEFT	190	2174 mm	N304 2174	CC Con carbonio - With carbon
	220-240	2631 mm	N304 2631	SC Senza carbonio - Without carbon
	280	2961 mm	N304 2961	

Nastri originali Lamiflex

Original Lamiflex flexible tapes

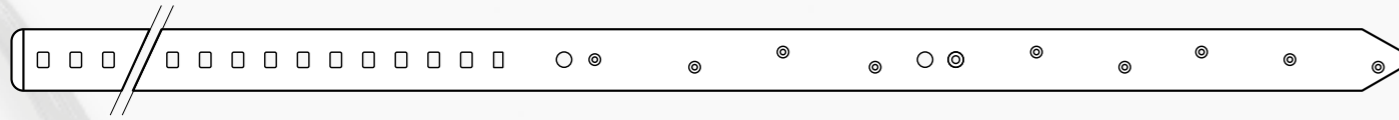

ART. N305 SX/LEFT	Telaio/Loom GTM-AS	Lungh. nastro Tape length	Codice Lamiflex Lamiflex Code
	190	2218 mm	N305 2218 C1
	220-240	2574 mm	N305 2574 C2
	280	2904 mm	N305 2904 C2

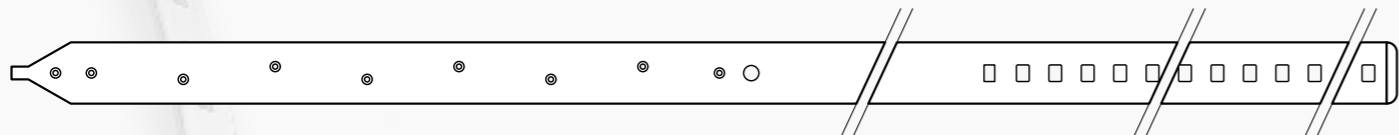

ART. N325 DX/RIGHT	Telaio/Loom GTM-AS	Lungh. nastro Tape length	Codice Lamiflex Lamiflex Code
	190	2193 mm	N325 2193 C2
	220-240	2612 mm	N325 2612 C2

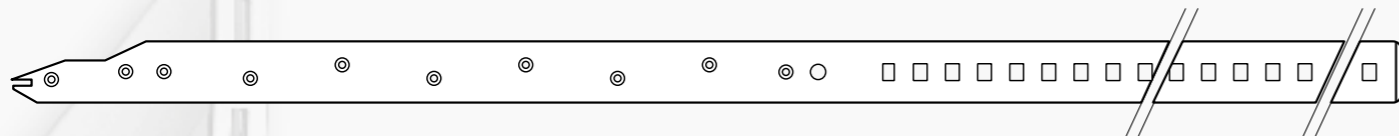

ART. N306 DX/RIGHT	Telaio/Loom GTM-AS	Lungh. nastro Tape length	Codice Lamiflex Lamiflex Code	
	190	2269 mm	N306 2269 C1	
	220-240	2637 mm	N306 2637 C2	
	280	2967 mm	N306 2967 C2	

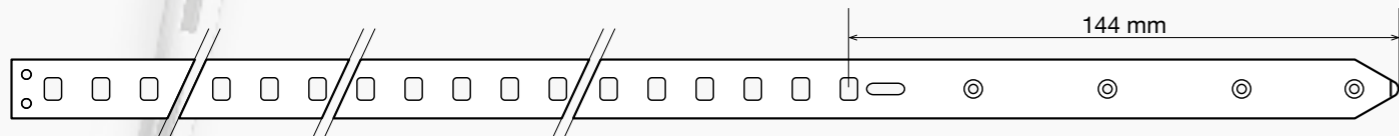

ART. N336 SX/LEFT	Telaio/Loom GAMMA	Lungh. nastro Tape length	Codice Lamiflex Lamiflex Code

Nastri originali Lamiflex

Original Lamiflex flexible tapes

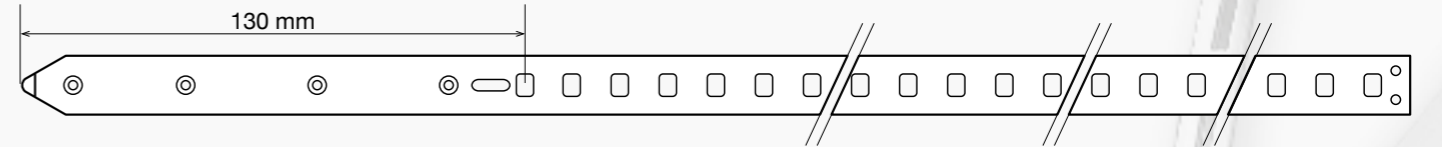

ART. N337 DX/RIGHT	Telaio/Loom GAMMA	Lungh. nastro Tape length	Codice Lamiflex Lamiflex Code

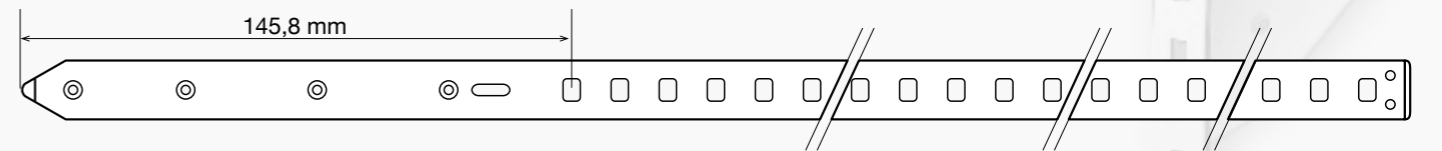

ART. N337 A DX/RIGHT	Telaio/Loom GAMMA	Lungh. nastro Tape length	Codice Lamiflex Lamiflex Code

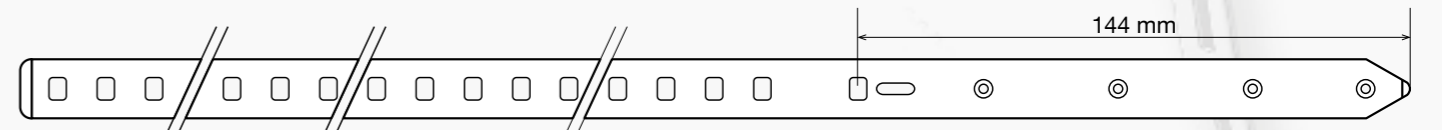

ART. N338 SX/LEFT	Telaio/Loom GAMMA	Lungh. nastro Tape length	Codice Lamiflex Lamiflex Code
	220	2580 mm	N338 2580 FN
	250	2735 mm	N338 2735 FN
	300	2974 mm	N338 2974 FN
	340	3177 mm	N338 3177 FN



ART. N339 DX/RIGHT	Telaio/Loom GAMMA	Lungh. nastro Tape length	Codice Lamiflex Lamiflex Code
	220	2608 mm	N339 2608 FN
	250	2764 mm	N339 2764 FN
	300	3003 mm	N339 3003 FN
	340	3219 mm	N339 3219 FN

Nastri originali Lamiflex

Original Lamiflex flexible tapes

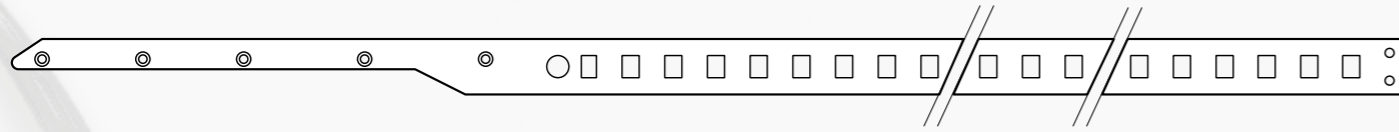

ART. N307 DX/RIGHT	Telaio/Loom GAMMA	Lungh. nastro Tape length	Codice Lamiflex Lamiflex Code
	190	1769 mm	N307 1769

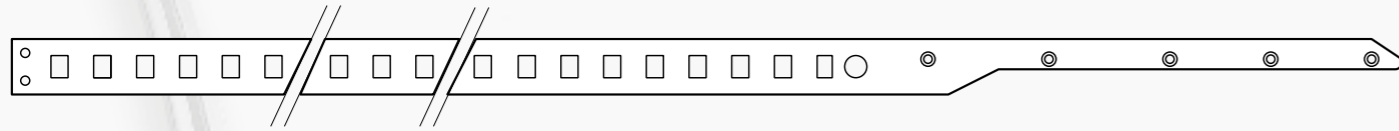

ART. N308 SX/LEFT	Telaio/Loom GAMMA	Lungh. nastro Tape length	Codice Lamiflex Lamiflex Code
	190	1732 mm	N308 1732

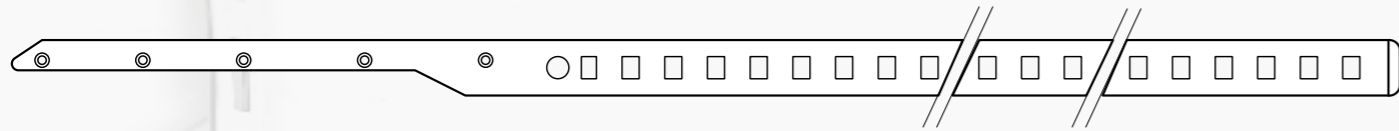

ART. N309 DX/RIGHT	Telaio/Loom GAMMA	Lungh. nastro Tape length	Codice Lamiflex Lamiflex Code
	220	2649 mm	N309 2649
	250	2802 mm	N309 2802
	300	3043 mm	N309 3043
	340	3259 mm	N309 3259
	380	3437 mm	N309 3437

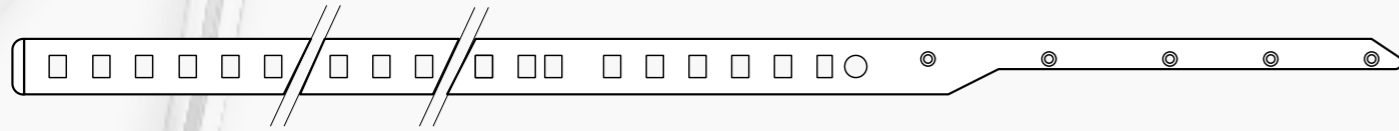

ART. N310 SX/LEFT	Telaio/Loom GAMMA	Lungh. nastro Tape length	Codice Lamiflex Lamiflex Code
	220	2612 mm	N310 2612
	250	2764 mm	N310 2764
	300	3006 mm	N310 3006
	340	3209 mm	N310 3209
	380	3412 mm	N310 3412

Nastri originali Lamiflex

Original Lamiflex flexible tapes

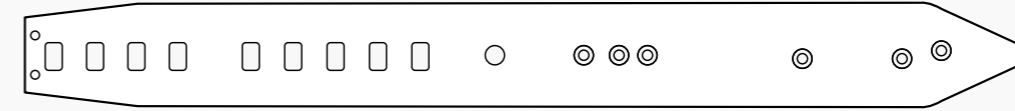

ART. N355 SX/LEFT	Telaio/Loom GAMMAX	Lungh. nastro Tape length	Codice Lamiflex Lamiflex Code
	190	1808 mm	N355 1808
	210	2668 mm	N355 2668
	220	2711 mm	N355 2711
	230	2767 mm	N355 2767
	250	2864 mm	N355 2864
	300	3113 mm	N355 3113
	320	3214 mm	N355 3214
340	3322 mm	N355 3322	

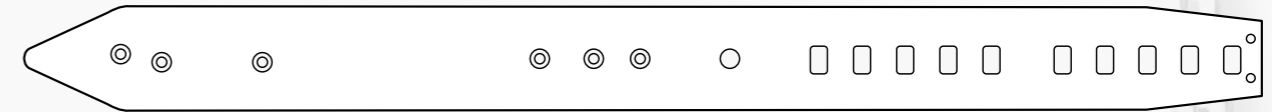

ART. N356 DX/RIGHT	Telaio/Loom GAMMAX	Lungh. nastro Tape length	Codice Lamiflex Lamiflex Code
	190	1846 mm	N356 1846
	220	2737 mm	N356 2737
	250	2890 mm	N356 2890
	300	3138 mm	N356 3138
340	3348 mm	N356 3348	

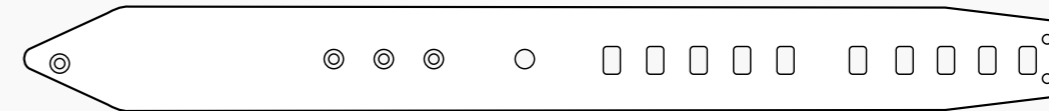

ART. N357 DX/RIGHT	Telaio/Loom GAMMAX	Lungh. nastro Tape length	Codice Lamiflex Lamiflex Code
	190	1796 mm	N357 1796
	210	2643 mm	N357 2643
	220	2687 mm	N357 2687
	230	2742 mm	N357 2742
	250	2840 mm	N357 2840
	300	3088 mm	N357 3088
	320	3189 mm	N357 3189
	340	3298 mm	N357 3298

Nastri originali Lamiflex

Original Lamiflex flexible tapes

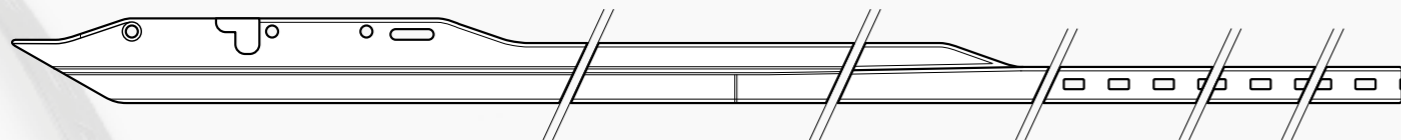

ART. N366	Telaio/Loom OPTIMAX	Lungh. nastro Tape length	Codice Lamiflex Lamiflex Code
DX/RIGHT	190	2498 mm	N366 2498
POLIESTERE POLYESTER	210/220	2655 mm	N366 2655
	230/250	2798 mm	N366 2798
	300/380	3448 mm	N366 3448
	400/460	3928 mm	N366 3928

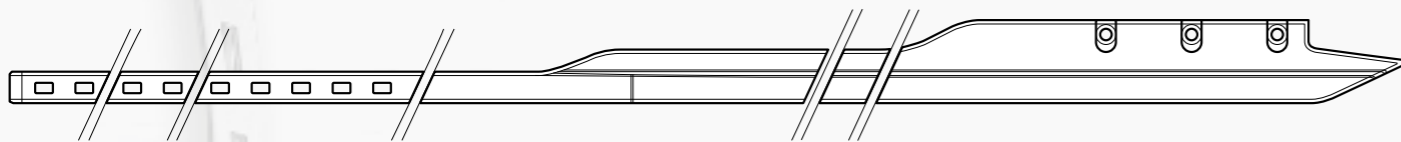

ART. N367	Telaio/Loom OPTIMAX	Lungh. nastro Tape length	Codice Lamiflex Lamiflex Code
SX/LEFT	190	2498 mm	N367 2498
POLIESTERE POLYESTER	210/220	2655 mm	N367 2655
	230/250	2798 mm	N367 2798
	300/380	3448 mm	N367 3448
	400/460	3928 mm	N367 3928

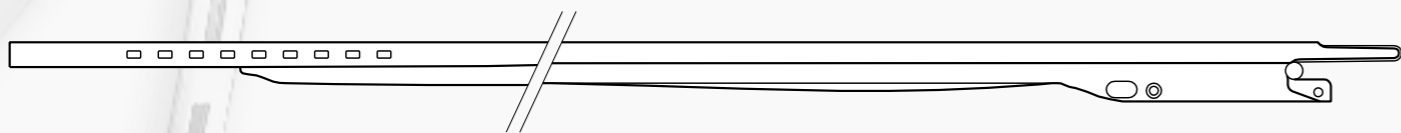

ART. N374	Telaio/Loom OPTIMAX	Lungh. nastro Tape length	Codice Lamiflex Lamiflex Code
DX/RIGHT	190	2601 mm	N374 2601
POLIESTERE POLYESTER			

Nastri originali Lamiflex

Original Lamiflex flexible tapes

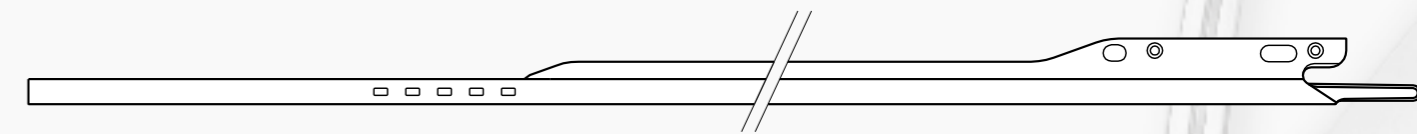

ART. N375	Telaio/Loom OPTIMAX	Lungh. nastro Tape length	Codice Lamiflex Lamiflex Code
SX/LEFT	190	2601 mm	N375 2601
POLIESTERE POLYESTER			

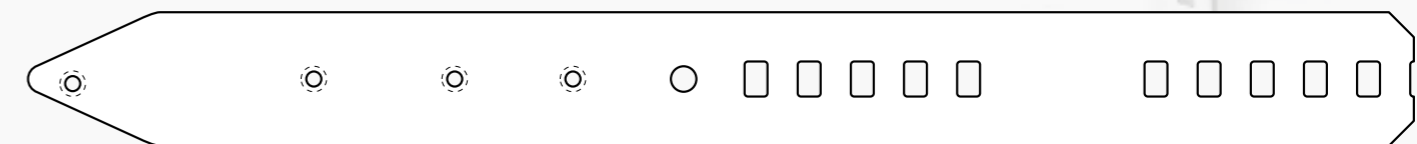

ART. N368	Telaio/Loom OPTIMAX	Lungh. nastro Tape length	Codice Lamiflex Lamiflex Code
DX/RIGHT	190	2393 mm	N368 2393
CARBONIO CARBON	230	2599 mm	N368 2599
	250	2696 mm	N368 2696
	320	3043 mm	N368 3043
	360	3249 mm	N368 3249

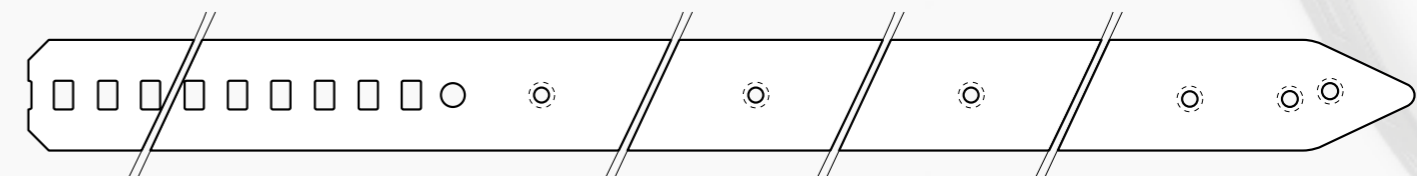

ART. N371	Telaio/Loom OPTIMAX	Lungh. nastro Tape length	Codice Lamiflex Lamiflex Code
SX/LEFT	190	2443 mm	N371 2443
	250	2649 mm	N371 2649
	320	3094 mm	N371 3094
	360	3300 mm	N371 3300

Nastri originali Lamiflex

Original Lamiflex flexible tapes

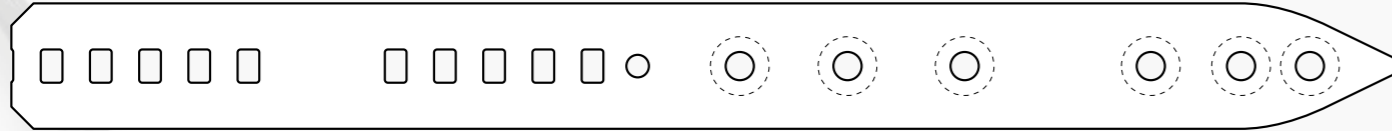

ART. N369	Telaio/Loom OPTIMAX	Lungh. nastro Tape length	Codice Lamiflex Lamiflex Code
SX/LEFT	190	2447 mm	N369 2447
CARBONIO CARBON	230	2653 mm	N369 2653
	250	2751 mm	N369 2751
	320	3097 mm	N369 3097
	360	3303 mm	N369 3303

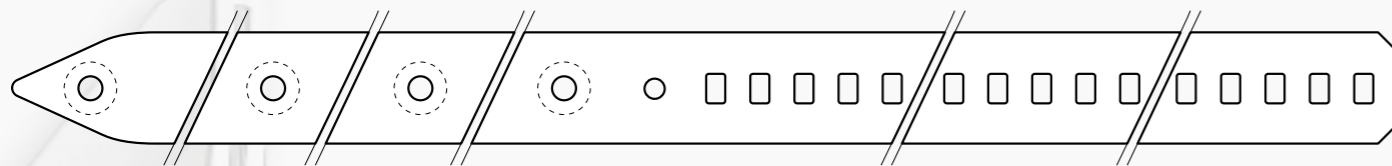

ART. N370	Telaio/Loom OPTIMAX	Lungh. nastro Tape length	Codice Lamiflex Lamiflex Code
DX/RIGHT	190	2398 mm	N370 2398
	230	2599 mm	N370 2599
	250	2700 mm	N370 2700
	320	3050 mm	N370 3050
	360	3255 mm	N370 3255

Particolari originali Lamiflex

Original Lamiflex accessories

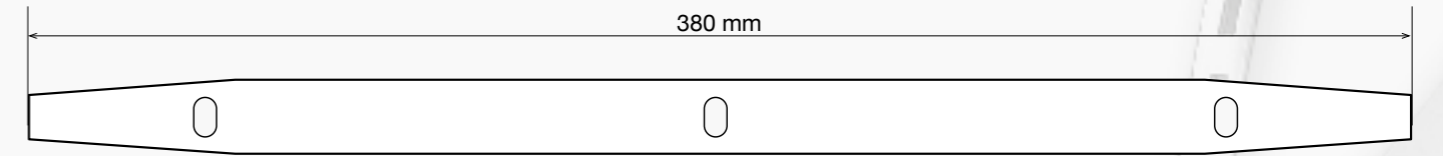

ART. P305

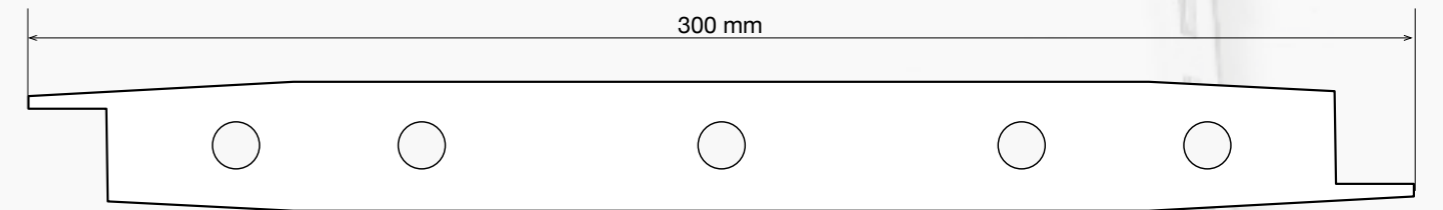

ART. P307

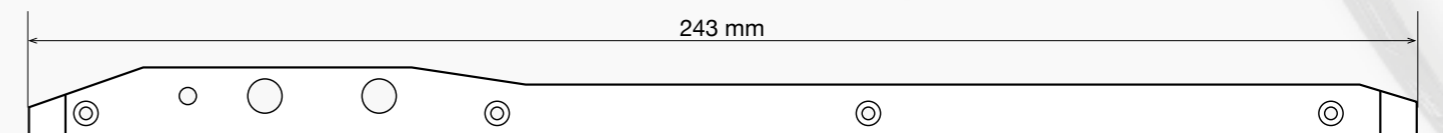

ART. P311

Particolari originali Lamiflex

Original Lamiflex accessories

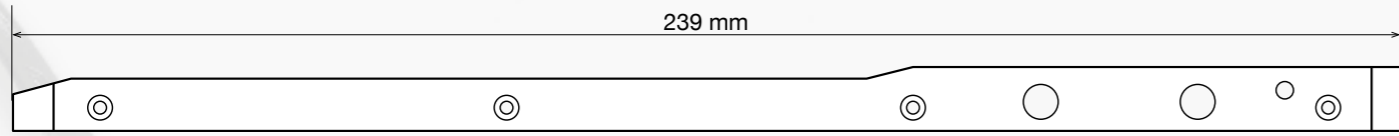

ART. P312

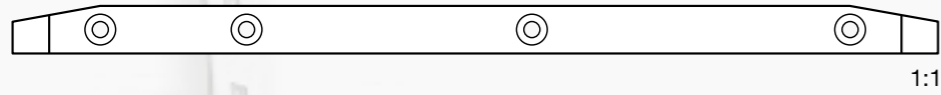

ART. P313

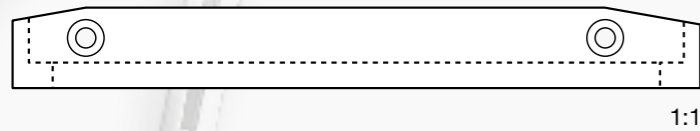

ART. P314

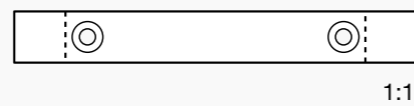

ART. P315

Particolari originali Lamiflex

Original Lamiflex accessories

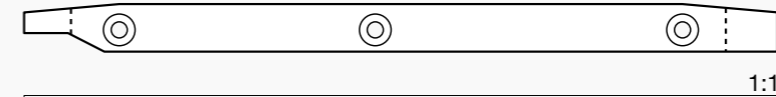

ART. P316

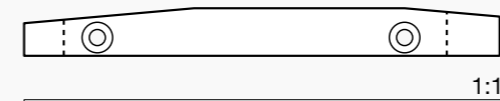

ART. P317



ART. P320

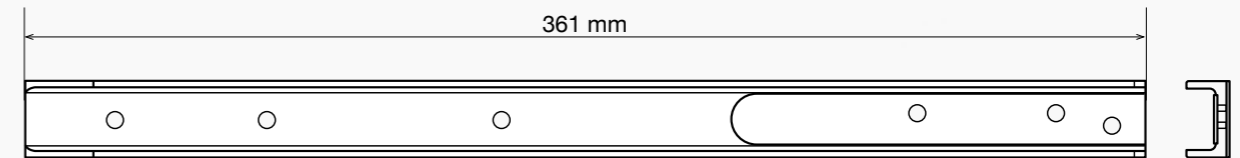

ART. C037

SUPPORTO IN CARBONIO SX/CARBON SUPPORT LEFT

Particolari originali Lamiflex

Original Lamiflex accessories

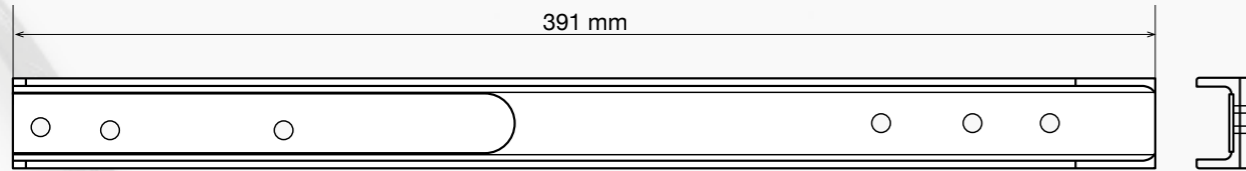

ART. C038

SUPPORTO IN CARBONIO DX/CARBON SUPPORT RIGHT

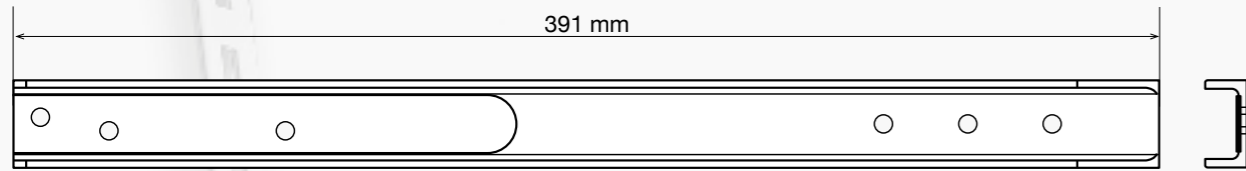

ART. C039

SUPPORTO IN CARBONIO DX/CARBON SUPPORT RIGHT

Nastri originali Lamiflex

Original Lamiflex flexible tapes

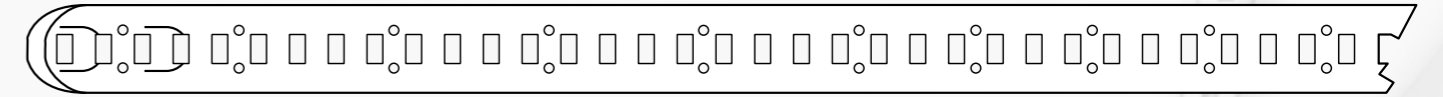

ART. N401	Telaio/Loom TP 300-TP 400	Lungh. nastro Tape length	Codice Lamiflex Lamiflex Code
DX-SX/RIGHT-LEFT	190	1620 mm	N401 1620
	210	1720 mm	N401 1720
	230	1818 mm	N401 1818
	250	1916 mm	N401 1916
	290	2120 mm	N401 2120
	330	2316 mm	N401 2316
	360	2468 mm	N401 2468
	410	3000 mm	N401 3000
	550	3868 mm	N401 3868

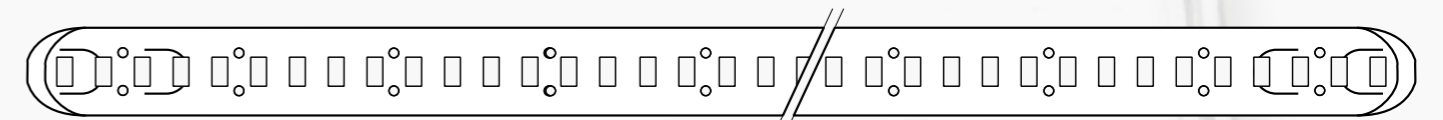

ART. N402	Telaio/Loom TP 300	Lungh. nastro Tape length	Codice Lamiflex Lamiflex Code
DX-SX/RIGHT-LEFT	210	2010 mm	N402 2010
	250	2213 mm	N402 2213
	330	2620 mm	N402 2620
	360	2766 mm	N402 2766
	410	3016 mm	N402 3016
FINITO DA AMBO LE PARTI FINISHED ON BOTH SIDES			

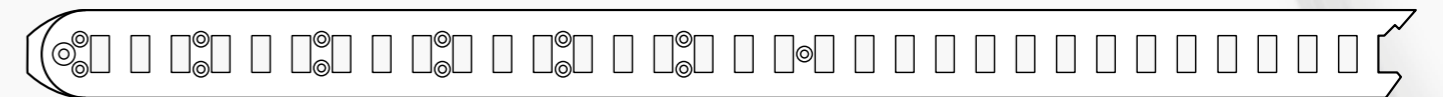

ART. N403	Telaio/Loom TP 300-TP 400	Lungh. nastro Tape length	Codice Lamiflex Lamiflex Code
DX-SX/RIGHT-LEFT	200	1655 mm	N403 1655
	220	1752 mm	N403 1752
	240	1850 mm	N403 1850
	260	1948 mm	N403 1948
	290	2154 mm	N403 2154
	330	2348 mm	N403 2348
	360	2500 mm	N403 2500
	410	2748 mm	N403 2748
PINZA VERTICALE VERTICAL GRIPPER			

Nastri originali Lamiflex

Original Lamiflex flexible tapes



ART. N404	Telaio/Loom TP 500	Lungh. nastro Tape length	Codice Lamiflex Lamiflex Code
DX-SX/RIGHT-LEFT	200	2200 mm	N404 2200
	220	2310 mm	N404 2310
	240	2418 mm	N404 2418
	260	2505 mm	N404 2505
	290	2700 mm	N404 2700
	330	2895 mm	N404 2895
	360	3047 mm	N404 3047
	380	3265 mm	N404 3265
	440	3612 mm	N404 3612

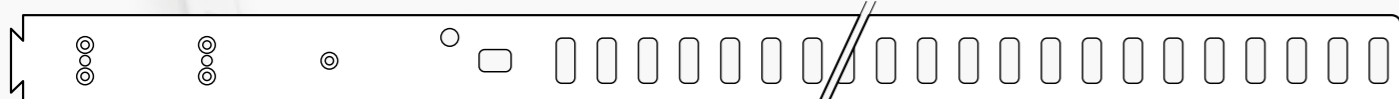

ART. N409	Telaio/Loom TP 500	Lungh. nastro Tape length	Codice Lamiflex Lamiflex Code
DX-SX/RIGHT-LEFT	200	2075 mm	N409 2075
	220	2185 mm	N409 2185
	240	2293 mm	N409 2293
	260	2380 mm	N409 2380
	290	2575 mm	N409 2575
	330	2770 mm	N409 2770
	360	2922 mm	N409 2922
	380	3140 mm	N409 3140
	440	3487 mm	N409 3487

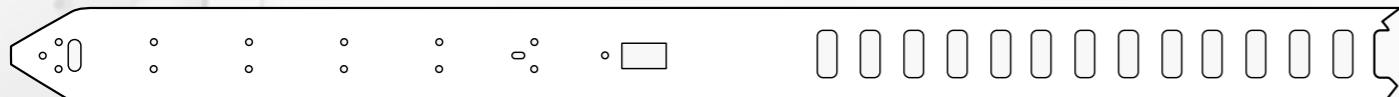

ART. N405	Telaio/Loom TP 600	Lungh. nastro Tape length	Codice Lamiflex Lamiflex Code
DX-SX/RIGHT-LEFT	200	2200 mm	N405 2200
	220	2310 mm	N405 2310
	240	2418 mm	N405 2418
	260	2505 mm	N405 2505
	290	2700 mm	N405 2700
	330	2895 mm	N405 2895
	360	3047 mm	N405 3047
	380	3265 mm	N405 3265
	440	3612 mm	N405 3612

Particolari originali Lamiflex

Original Lamiflex accessories

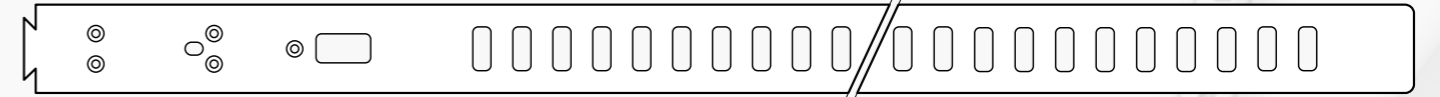

ART. N407	Telaio/Loom TP 600	Lungh. nastro Tape length	Codice Lamiflex Lamiflex Code
DX-SX/RIGHT-LEFT	200	2075 mm	N407 2075
	220	2185 mm	N407 2185
	240	2293 mm	N407 2293
	260	2380 mm	N407 2380
	290	2575 mm	N407 2575
	330	2770 mm	N407 2770
	360	2922 mm	N407 2922
	380	3140 mm	N407 3140
	440	3487 mm	N407 3487

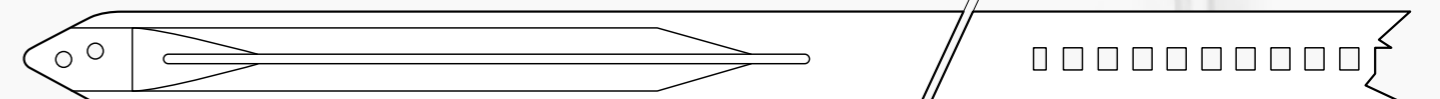

ART. N406	Telaio/Loom FAST G 6300	Lungh. nastro Tape length	Codice Lamiflex Lamiflex Code
DX-SX/RIGHT-LEFT	170	2510 mm	N406 2510
	190	2608 mm	N406 2608
	200	2650 mm	N406 2650
	220	2748 mm	N406 2748
	240	2846 mm	N406 2846
	260	2944 mm	N406 2944
	290	3150 mm	N406 3150
	320	3355 mm	N406 3355
	340	3450 mm	N406 3450
	360	3550 mm	N406 3550

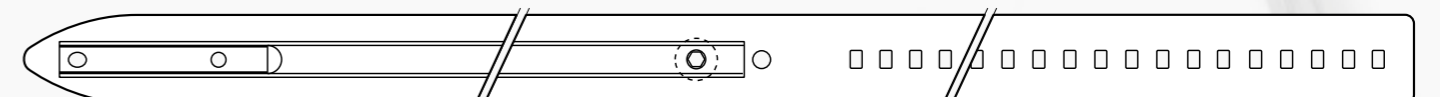

ART. N410	Telaio/Loom WSC GS 900	Lungh. nastro Tape length	Codice Lamiflex Lamiflex Code
DX-SX/RIGHT-LEFT	170	2532 mm	N410 2532
	190	2630 mm	N410 2630
	200	2672 mm	N410 2672
	220	2770 mm	N410 2770
	230	2822 mm	N410 2822
	240	2868 mm	N410 2868
	260	2966 mm	N410 2966
	290	3172 mm	N410 3172
	320	3377 mm	N410 3377
	340	3472 mm	N410 3472
	360	3572 mm	N410 3572

Nastri originali Lamiflex

Original Lamiflex flexible tapes

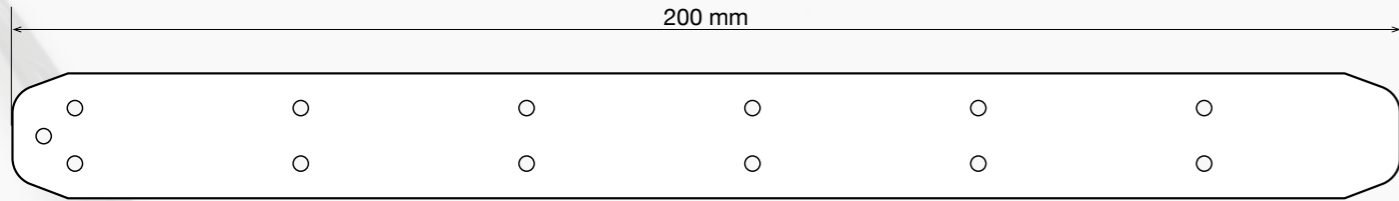

ART. P407

LISTA SOPRANASTRO/TAPE SUPPORT

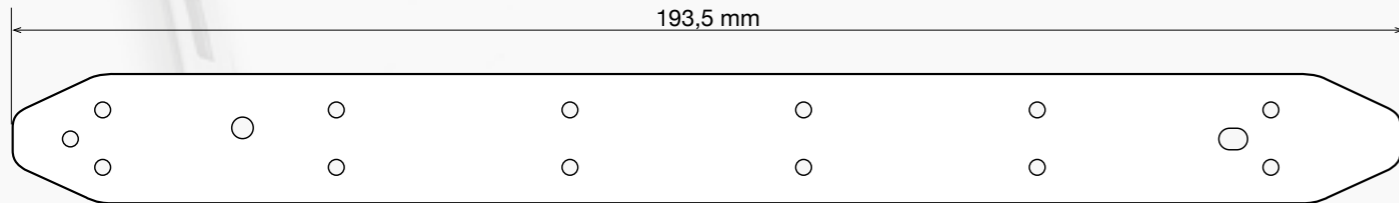

ART. P408

LISTA SOPRANASTRO/TAPE SUPPORT

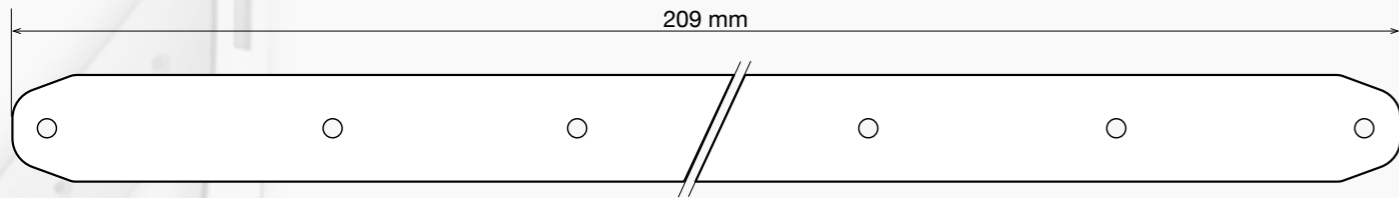

ART. P510

LISTA SOTTONASTRO/TAPE SUPPORT

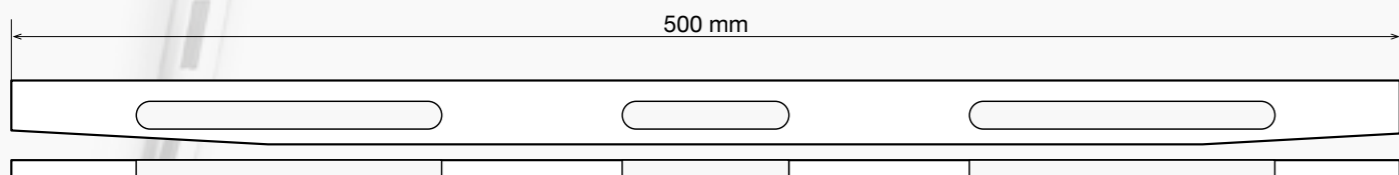

ART. P411

LISTA SGANCIATRAMA/OPENER

Particolari originali Lamiflex

Original Lamiflex accessories

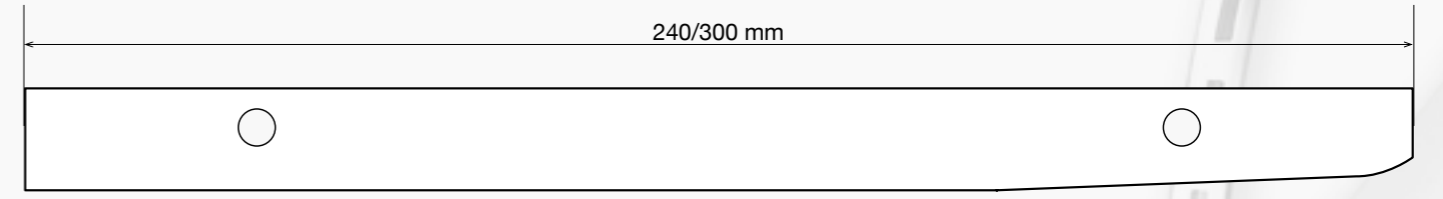

ART. P412

LISTA APRIPINZA/OPENER

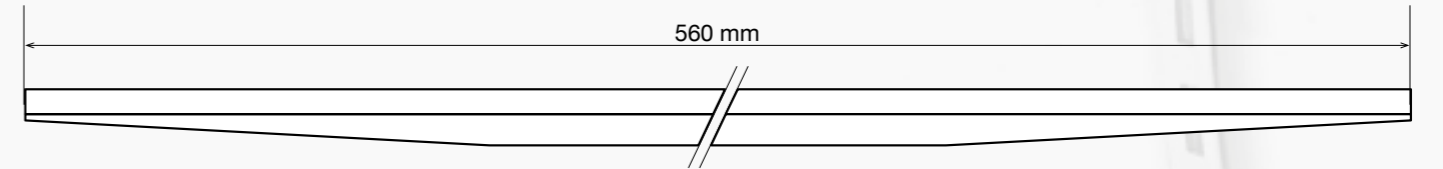

ART. P413

LISTA SGANCIATRAMA/OPENER

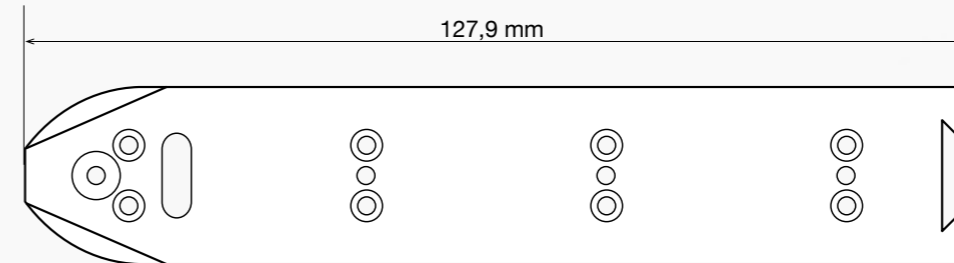

ART. P416

PUNTA NASTRO TP 500/TAPE POINT FOR TP 500

Particolari originali Lamiflex

Original Lamiflex accessories

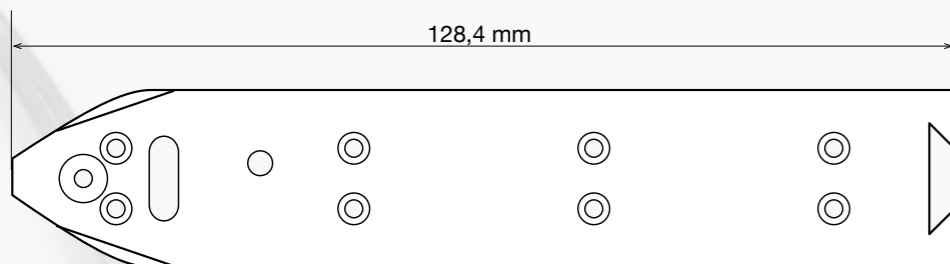

ART. P417

PUNTA NASTRO TP 600/TAPE POINT FOR TP 600



ART. P419

SUPPORTO PINZA/GRIPPER SUPPORT

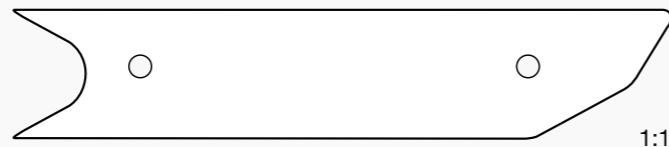

ART. P420

SUPPORTO PINZA/GRIPPER SUPPORT

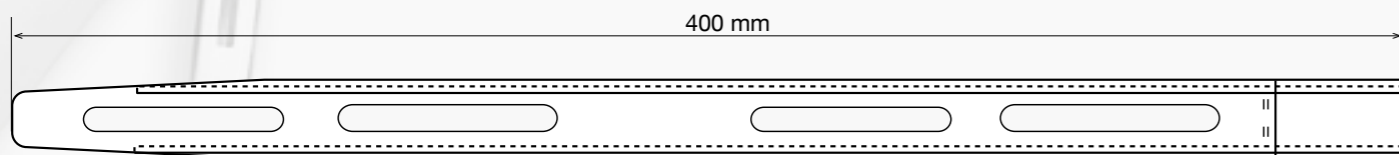

ART. P851#LP FN &

LISTA SGANCIATRAMA/OPENER

Nastri originali Lamiflex

Original Lamiflex flexible tapes

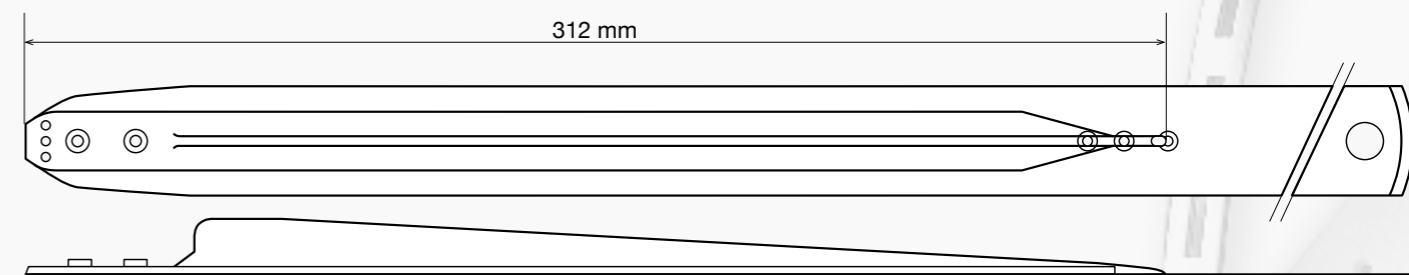

ART. N501	Telaio/Loom F 2001	Lungh. nastro Tape length	Codice Lamiflex Lamiflex Code	Variante Variant
DX/RIGHT	140-160	1592 mm	N501 1592	CA In carbonio - In carbon (spessore - thickness 1,3 mm)
	170-190	1675 mm	N501 1675	
	170-190	1710 mm	N501 1710	
	200-220	1860 mm	N501 1860	K In kevlar (spessore - thickness 1,6 mm)
	230-250	2025 mm	N501 2025	
	260-280	2182 mm	N501 2182	

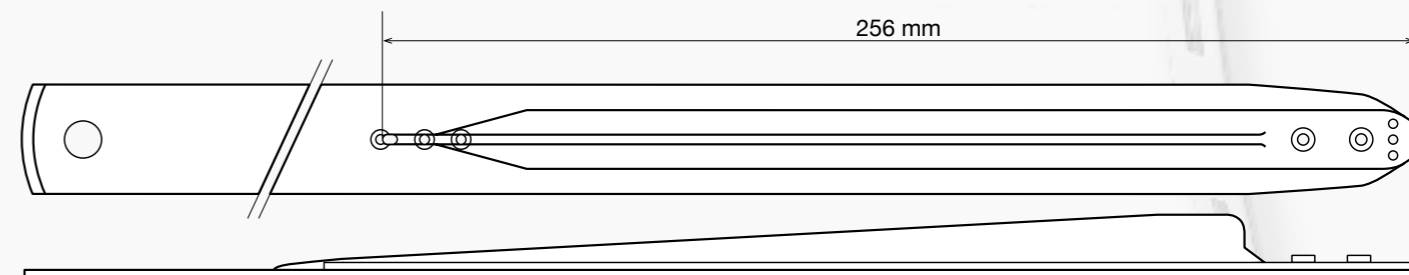

ART. N502	Telaio/Loom F 2001	Lungh. nastro Tape length	Codice Lamiflex Lamiflex Code	Variante Variant
SX/LEFT	140-160	1542 mm	N502 1542	CA In carbonio - In carbon (spessore - thickness 1,3 mm)
	170-190	1660 mm	N502 1660	
	200-220	1810 mm	N502 1810	
	230-250	1975 mm	N502 1975	K In kevlar (spessore - thickness 1,6 mm)
	260-280	2132 mm	N502 2132	
	290	2179 mm	N502 2179	

Nastri originali Lamiflex
Original Lamiflex flexible tapes



ALTA TECNOLOGIA DEI COMPOSITI

Tutti i prodotti indicati ed illustrati nel presente catalogo sono realizzati da Lamiflex. L'indicazione quindi, all'interno del medesimo, di altri marchi diversi da Lamiflex ha funzione meramente descrittiva e non distintiva, così come previsto dall'Art. 21 - Decreto D.Lgs. 10-02-2005, n. 30.

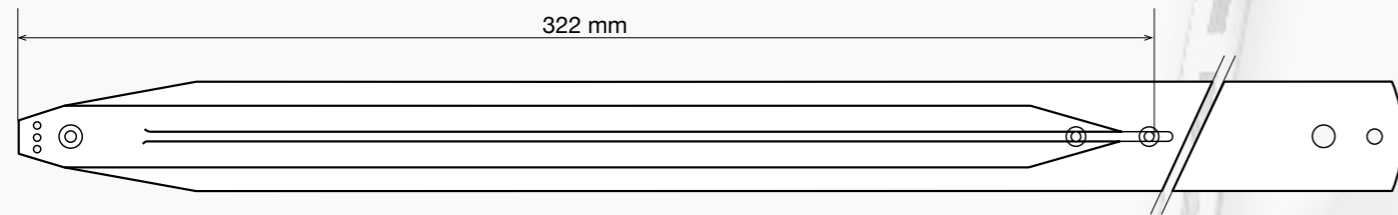

ART. N506	Telaio/Loom G 6100	Lungh. nastro Tape length	Codice Lamiflex Lamiflex Code	Variante Variant
DX/RIGHT	40-160	1663 mm	N506 1663	FLEXIBLE TALE CA In carbonio - In carbon (spessore - thickness 1,3 mm) K In kevlar (spessore - thickness 1,6 mm)
	170-190	1813 mm	N506 1813	
	200-220	1963 mm	N506 1963	
	230-250	2113 mm	N506 2113	
	260-280	2263 mm	N506 2263	
	290	2363 mm	N506 2363	

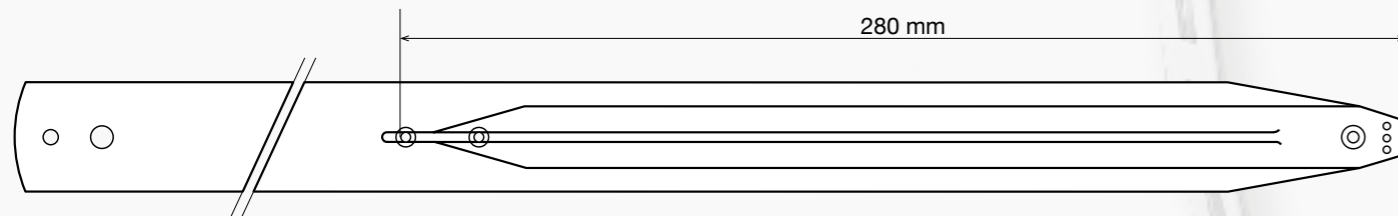

ART. N507	Telaio/Loom G 6100	Lungh. nastro Tape length	Codice Lamiflex Lamiflex Code	Variante Variant
SX/LEFT	140-180	1692 mm	N507 1692	FLEXIBLE TALE CA In carbonio - In carbon (spessore - thickness 1,3 mm)
	190-210	1842 mm	N507 1842	
	220-250	2042 mm	N507 2042	
	260-290	2242 mm	N507 2242	



ALTA TECNOLOGIA DEI COMPOSITI

Tutti i prodotti indicati ed illustrati nel presente catalogo sono realizzati da Lamiflex. L'indicazione quindi, all'interno del medesimo, di altri marchi diversi da Lamiflex ha funzione meramente descrittiva e non distintiva, così come previsto dall'Art. 21 - Decreto D.Lgs. 10-02-2005, n. 30.

Nastri originali Lamiflex
Original Lamiflex flexible tapes

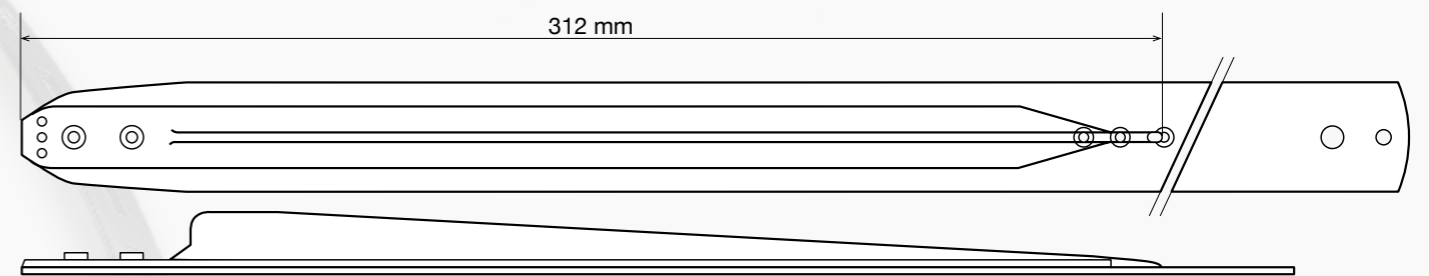

ART. N504	Telaio/Loom F 2001	Lungh. nastro Tape length	Codice Lamiflex Lamiflex Code	Variante Variant
DX/RIGHT	140-160	1619 mm	N504 1619	FLEXIBLE TALE CA In carbonio - In carbon (spessore - thickness 1,3 mm) K In kevlar (spessore - thickness 1,6 mm)
	170-190	1769 mm	N504 1769	
	200-220	1919 mm	N504 1919	
	230-250	2069 mm	N504 2069	
	260-280	2219 mm	N504 2219	
	290	2269 mm	N504 2269	

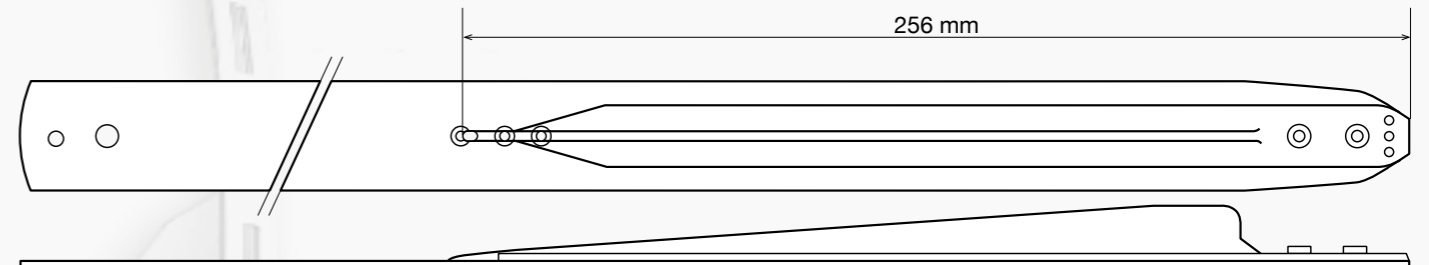

ART. N505	Telaio/Loom F 2001	Lungh. nastro Tape length	Codice Lamiflex Lamiflex Code	Variante Variant
SX/LEFT	140-160	1632 mm	N505 1632	FLEXIBLE TALE CA In carbonio - In carbon (spessore - thickness 1,3 mm) K In kevlar (spessore - thickness 1,6 mm)
	170-190	1782 mm	N505 1782	
	200-220	1932 mm	N505 1932	
	230-250	2082 mm	N505 2082	
	260-280	2232 mm	N505 2232	
	290	2282 mm	N505 2282	

Nastri originali Lamiflex

Original Lamiflex flexible tapes

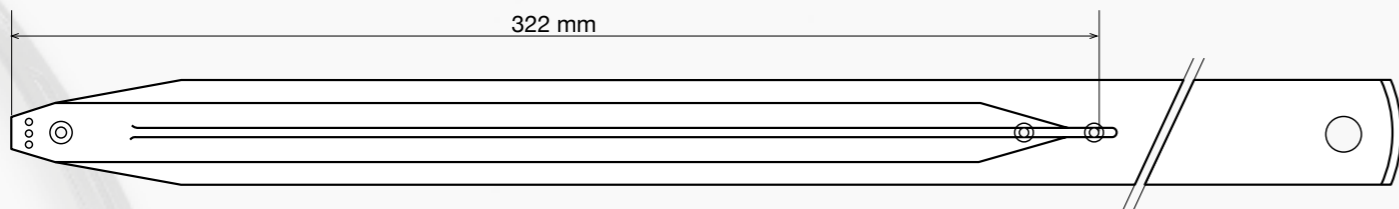

ART. N508 DX-SX/RIGHT-LEFT	Telaio/Loom G 6100	Lungh. nastro Tape length	Codice Lamiflex Lamiflex Code	Variante Variant
	140-160	1638 mm	N508 1638	CA In carbonio - In carbon
	170-190	1756 mm	N508 1756	
	200-220	1906 mm	N508 1906	
	230-250	2071 mm	N508 2071	
	260-280	2228 mm	N508 2228	

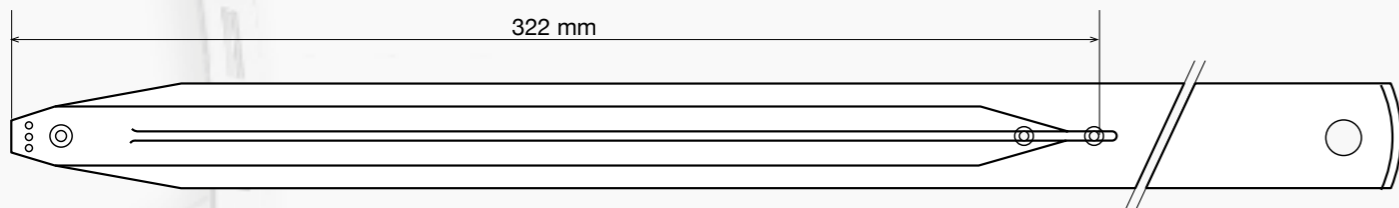

ART. N509 DX/RIGHT	Telaio/Loom G 6100	Lungh. nastro Tape length	Codice Lamiflex Lamiflex Code	Variante Variant
	140-160	1638 mm	N509 1638	K In kevlar (spessore - thickness 1,6 mm)
	170-190	1756 mm	N509 1756	
	200-220	1906 mm	N509 1906	
	230-250	2071 mm	N509 2071	
	260-280	2228 mm	N509 2228	

ART. N509 SX/LEFT	Telaio/Loom G 6100	Lungh. nastro Tape length	Codice Lamiflex Lamiflex Code	Variante Variant
	140-160	1573 mm	N509 1573	K In kevlar (spessore - thickness 1,6 mm)
	170-190	1691 mm	N509 1691	
	200-220	1841 mm	N509 1841	
	230-250	2006 mm	N509 2006	
	260-280	2163 mm	N509 2163	

Nastri originali Lamiflex

Original Lamiflex flexible tapes

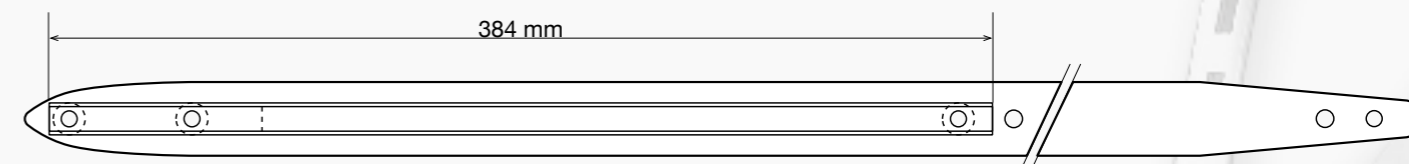

ART. N510 DX-SX/RIGHT-LEFT	Telaio/Loom G 6200	Lungh. nastro Tape length	Codice Lamiflex Lamiflex Code	Variante Variant
	-	1884 mm	N510 1884	CA In carbonio - In carbon (spessore - thickness 1,1 mm)
	-	2134 mm	N510 2134	
	-	2434 mm	N510 2434	K In Kevlar (spessore - thickness 1,2 mm)
	-	2684 mm	N510 2684	

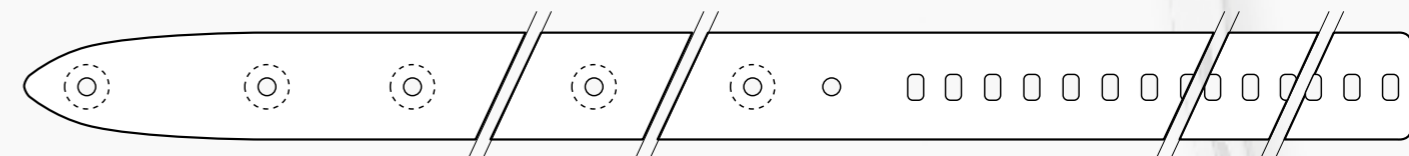

ART. N519 DX-SX/RIGHT-LEFT	Telaio/Loom G 6500	Lungh. nastro Tape length	Codice Lamiflex Lamiflex Code
	-	2510 mm	N519 2510
	-	2763 mm	N519 2763
	-	2961 mm	N519 2961
	-	3060 mm	N519 3060
	-	3357 mm	N519 3357
	-	3467 mm	N519 3467

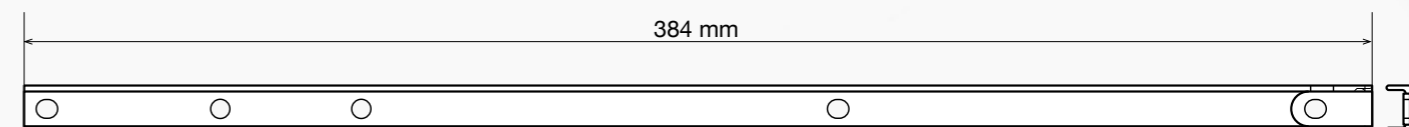

ART. C045#0384 FN &
RINFORZO AD U IN CARBONIO/U CARBON PROFILE

Particolari originali Lamiflex

Original Lamiflex accessories

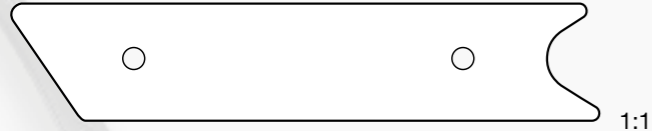

1:1

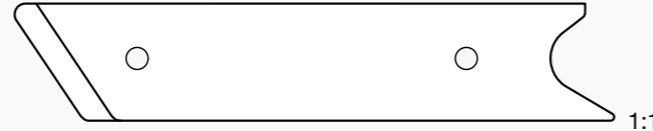

1:1

ART. P511

SUPPORTO PINZA/GRIPPER SUPPORT

ART. P512

SUPPORTO PINZA/GRIPPER SUPPORT



1:1

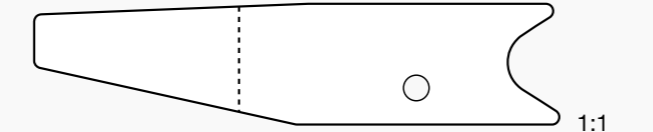

1:1

ART. P513

SUPPORTO PINZA/GRIPPER SUPPORT

ART. P514

SUPPORTO PINZA/GRIPPER SUPPORT

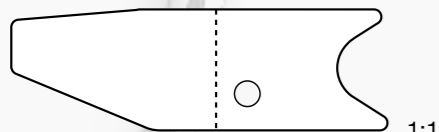

1:1

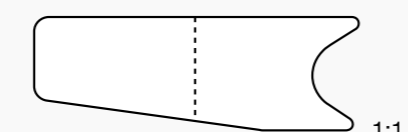

1:1

ART. P515

SUPPORTO PINZA/GRIPPER SUPPORT

ART. P517

SUPPORTO PINZA/GRIPPER SUPPORT

Nastri originali Lamiflex

Original Lamiflex flexible tapes

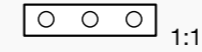

1:1

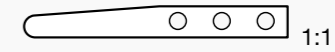

1:1

ART. P519

INSERTO/INSERT

ART. P520

INSERTO/INSERT

Spessori - Thickness:

0,5 mm;
0,6 mm;
0,7 mm;
0,8 mm.

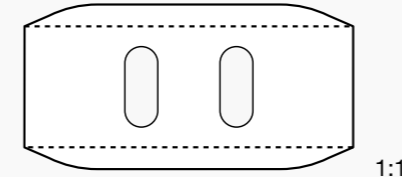

1:1

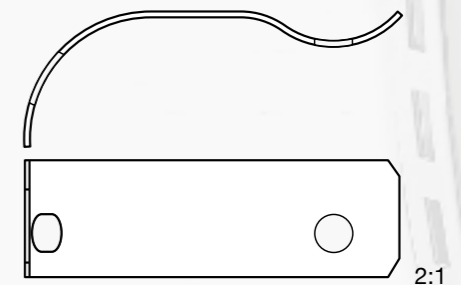

2:1

ART. P518

APRIPINZA/GRIPPER OPENER

ART. P523

MOLLETTINA/SPRING

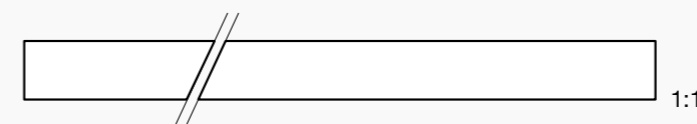

1:1

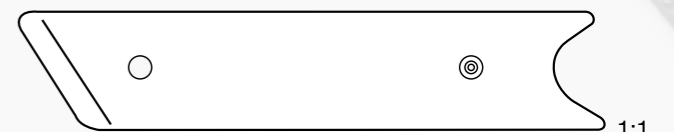

1:1

ART. P524

MOLLETTINA/SPRING

ART. P525

SUPPORTO PINZA/GRIPPER SUPPORT

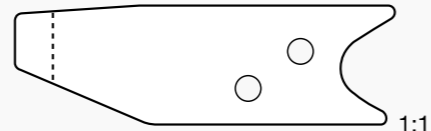
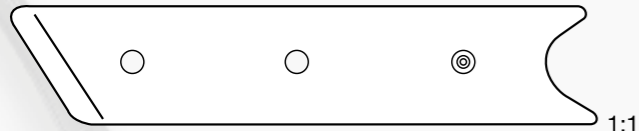

ART. P526

SUPPORTO PINZA/GRIPPER SUPPORT

ART. P527

SUPPORTO PINZA/GRIPPER SUPPORT

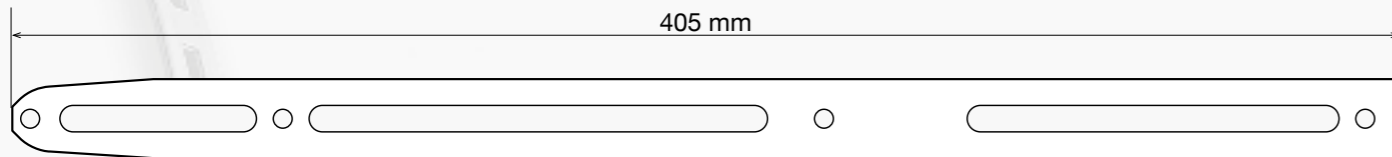

ART. P521

APRIPINZA/GRIPPER OPENER

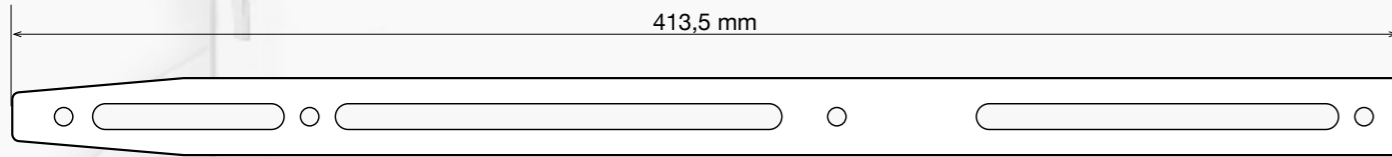

ART. P522

APRIPINZA/GRIPPER OPENER

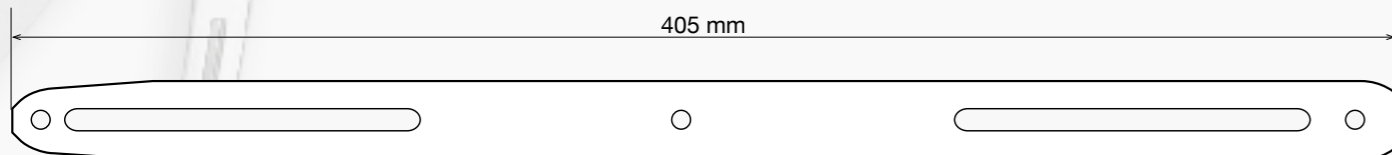

ART. P537

APRIPINZA/GRIPPER OPENER

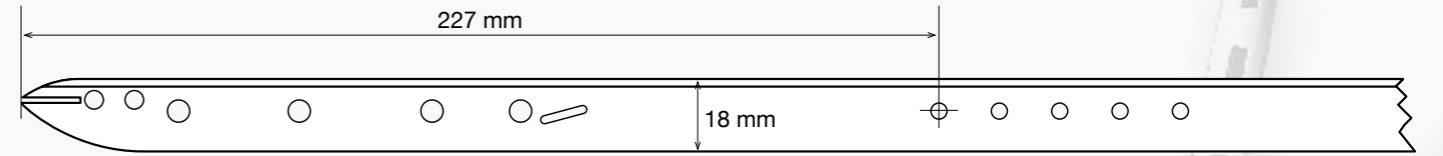

ART. N601 DX/RIGHT	Telaio/Loom MÜLLER	Lungh. nastro Tape length	Codice Lamiflex Lamiflex Code
	MUGRIP 3	1077 mm	N601 1077

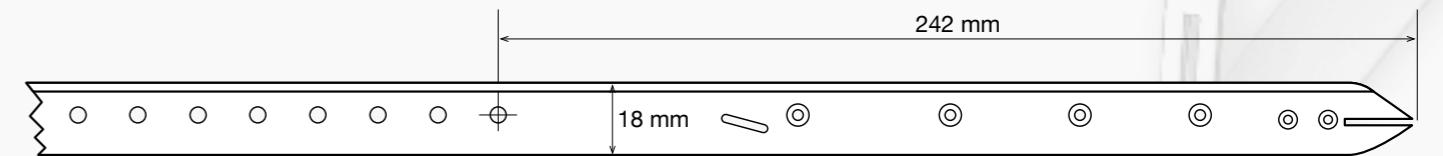

ART. N602 SX/LEFT	Telaio/Loom MÜLLER	Lungh. nastro Tape length	Codice Lamiflex Lamiflex Code
	MUGRIP 3	1092 mm	N602 1092

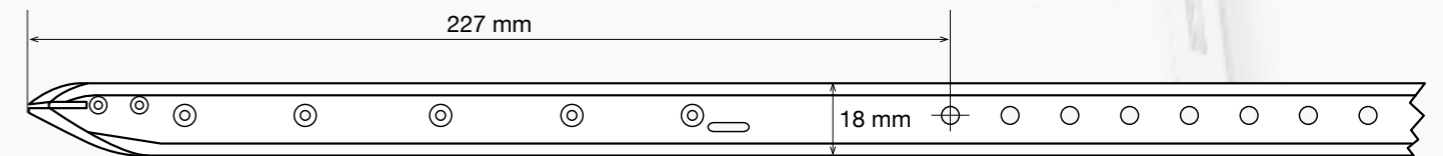

ART. N603 DX/RIGHT	Telaio/Loom MÜLLER	Lungh. nastro Tape length	Codice Lamiflex Lamiflex Code
	MUGRIP 3	1077 mm	N603 1077

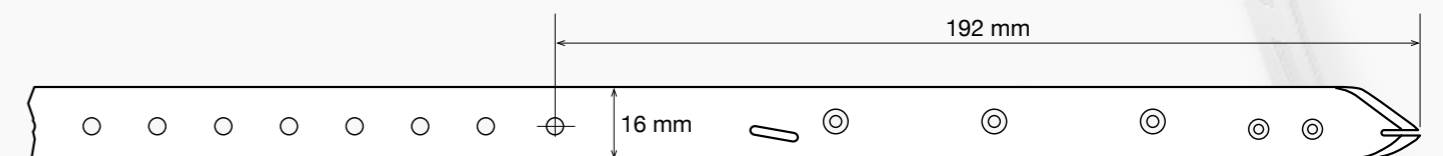

ART. N604 SX/LEFT	Telaio/Loom MÜLLER	Lungh. nastro Tape length	Codice Lamiflex Lamiflex Code
	MUGRIP 2	952 mm	N604 952

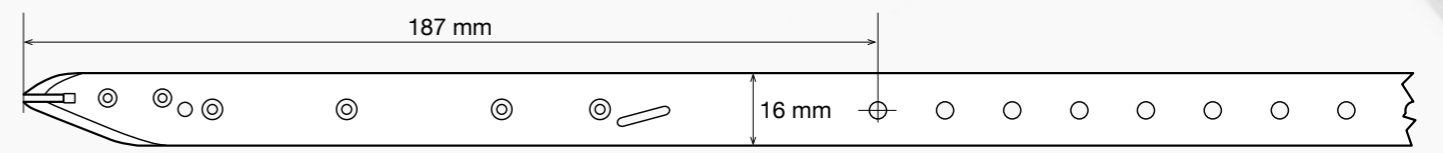

ART. N605 DX/RIGHT	Telaio/Loom MÜLLER	Lungh. nastro Tape length	Codice Lamiflex Lamiflex Code
	MUGRIP 2	947 mm	N605 947

Nastri originali Lamiflex

Original Lamiflex flexible tapes

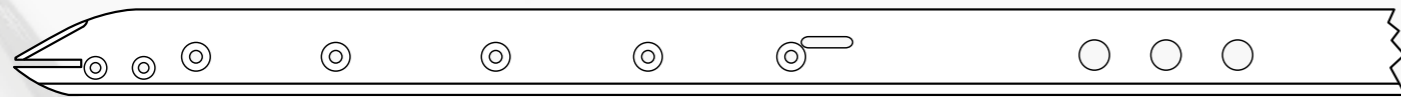

ART. N606 DX/RIGHT	Telaio/Loom MÜLLER	Lungh. nastro Tape length	Codice Lamiflex Lamiflex Code
	MUGRIP 5	1077 mm	N606 1077

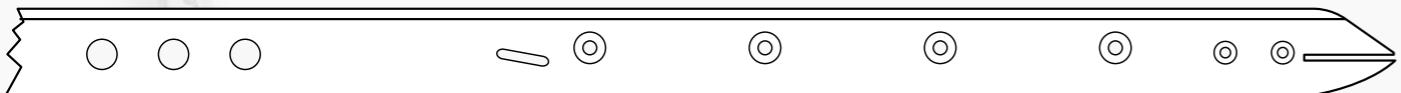

ART. N607 SX/LEFT	Telaio/Loom MÜLLER	Lungh. nastro Tape length	Codice Lamiflex Lamiflex Code
	MUGRIP 5	1092 mm	N607 1092

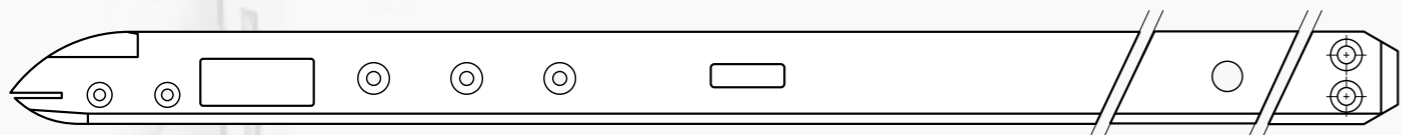

ART. N619 DX/RIGHT	Telaio/Loom MÜLLER	Lungh. nastro Tape length	Codice Lamiflex Lamiflex Code
	MUGRIP 5	1248 mm	N619 1248

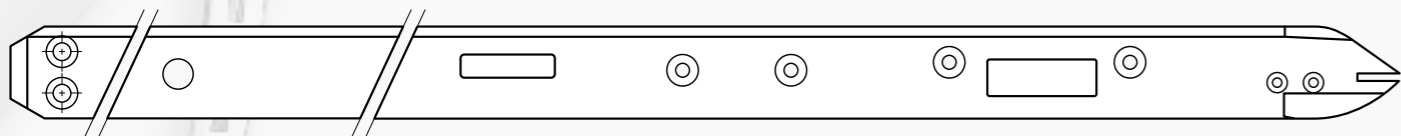

ART. N620 SX/LEFT	Telaio/Loom MÜLLER	Lungh. nastro Tape length	Codice Lamiflex Lamiflex Code
	MUGRIP 5	1321 mm	N620 1321

Nastri originali Lamiflex

Original Lamiflex flexible tapes

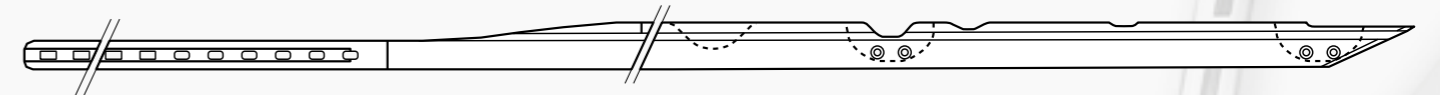

ART. N256 DX/RIGHT	Lunghezza nastro Tape length	Codice Lamiflex Lamiflex Code
	2274 mm	N256 2274
PINZA NEGATIVA NEGATIVE GRIPPER	2398 mm	N256 2398
	3130 mm	N256 3130
	3255 mm	N256 3225

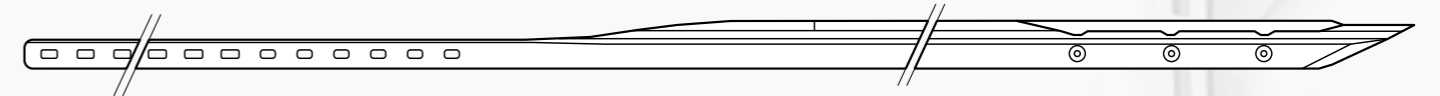

ART. N256 SX/LEFT	Lunghezza nastro Tape length	Codice Lamiflex Lamiflex Code
	2274 mm	N256 2274
PINZA NEGATIVA NEGATIVE GRIPPER	2398 mm	N256 2398
	3130 mm	N256 3130
	3255 mm	N256 3225

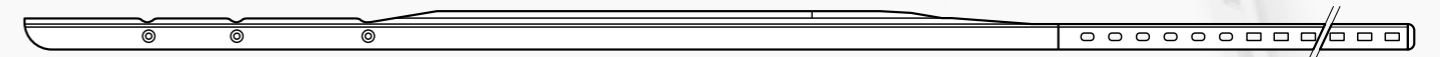

ART. N257 DX/RIGHT	Lunghezza nastro Tape length	Codice Lamiflex Lamiflex Code
	2283 mm	N257 2283
PINZA POSITIVA POSITIVE GRIPPER	3233 mm	N257 3233

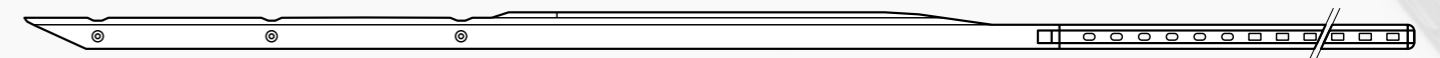

ART. N257 SX/LEFT	Lunghezza nastro Tape length	Codice Lamiflex Lamiflex Code
	2280 mm	N257 2280
PINZA POSITIVA POSITIVE GRIPPER	3230 mm	N257 3230

Particolari originali Lamiflex

Original Lamiflex accessories

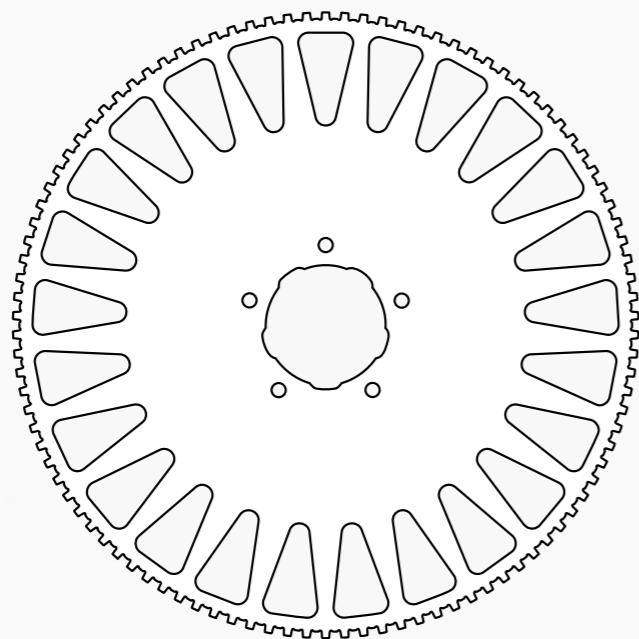

ART. R030#&

RUOTA DENTATA Ø 313 mm/THOOTHED WHEEL Ø 313 mm

Nastri originali Lamiflex

Original Lamiflex flexible tapes



ART. N808	Telaio/Loom VANDE WIELE	Lungh. nastro Tape length	Codice Lamiflex Lamiflex Code
DX-SX/RIGHT-LEFT		3100 mm	N808 3100

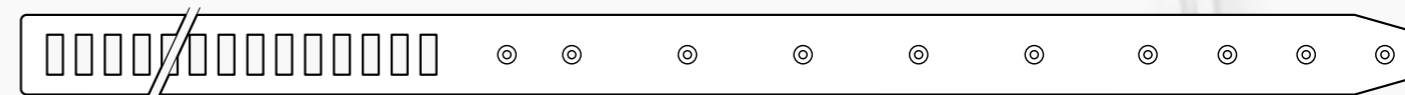

ART. N808A	Telaio/Loom VANDE WIELE	Lungh. nastro Tape length	Codice Lamiflex Lamiflex Code
DX-SX/RIGHT-LEFT		2410 mm	N808A 2410
		2707 mm	N808A 2707
		2970 mm	N808A 2970
		3370 mm	N808A 3370

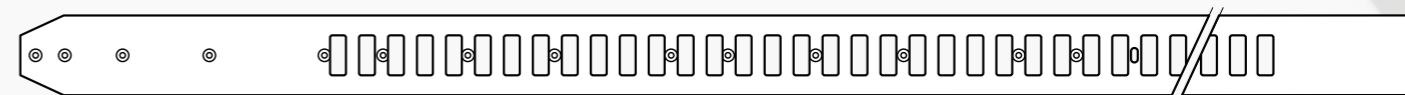

ART. N808B	Telaio/Loom VANDE WIELE	Lungh. nastro Tape length	Codice Lamiflex Lamiflex Code
DX-SX/RIGHT-LEFT		3100 mm	N808B 3100
		3600 mm	N808B 3600
		3900 mm	N808B 3900

Particolari originali Lamiflex

Original Lamiflex accessories

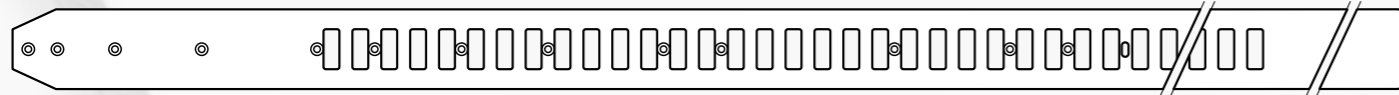

ART. N808C DX-SX/RIGHT-LEFT	Telaio/Loom VANDE WIELE	Lungh. nastro Tape length	Codice Lamiflex Lamiflex Code
		3900 mm	N808C 3900

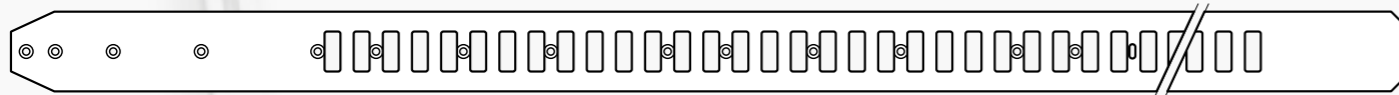

ART. N877A DX-SX/RIGHT-LEFT	Telaio/Loom VANDE WIELE	Lungh. nastro Tape length	Codice Lamiflex Lamiflex Code
		3609 mm	N877A 3609

Nastri originali Lamiflex

Original Lamiflex flexible tapes

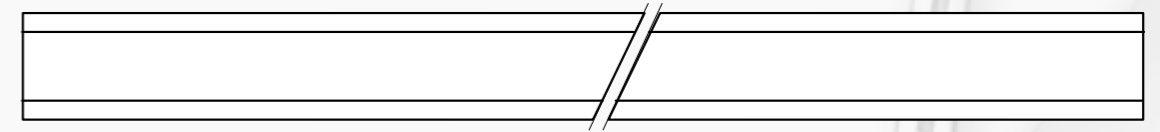
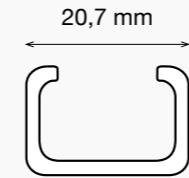

ART. PU005 Telaio/Loom DORNIER GTV/HTV	Lungh. nastro Tape length	Codice Lamiflex Lamiflex Code	Lungh. nastro Tape length	Codice Lamiflex Lamiflex Code
	1050 mm	PU005 1050	1670 mm	PU005 1670
	1100 mm	PU005 1100	1700 mm	PU005 1700
	1120 mm	PU005 1120	1720 mm	PU005 1720
	1150 mm	PU005 1150	1750 mm	PU005 1750
	1170 mm	PU005 1170	1770 mm	PU005 1770
	1200 mm	PU005 1200	1820 mm	PU005 1820
	1220 mm	PU005 1220	1850 mm	PU005 1850
	1250 mm	PU005 1250	1900 mm	PU005 1900
	1270 mm	PU005 1270	1920 mm	PU005 1920
	1300 mm	PU005 1300	1950 mm	PU005 1950
	1320 mm	PU005 1320	1970 mm	PU005 1970
	1350 mm	PU005 1350	2000 mm	PU005 2000
	1370 mm	PU005 1370	2020 mm	PU005 2020
	1400 mm	PU005 1400	2050 mm	PU005 2050
	1420 mm	PU005 1420	2070 mm	PU005 2070
	1450 mm	PU005 1450	2100 mm	PU005 2100
	1470 mm	PU005 1470	2120 mm	PU005 2120
	1500 mm	PU005 1500	2150 mm	PU005 2150
	1520 mm	PU005 1520	2200 mm	PU005 2200
1550 mm	PU005 1550	2220 mm	PU005 2220	
1570 mm	PU005 1570	2320 mm	PU005 2320	
1600 mm	PU005 1600	2450 mm	PU005 2450	
1620 mm	PU005 1620	3400 mm	PU005 3400	
1650 mm	PU005 1650			

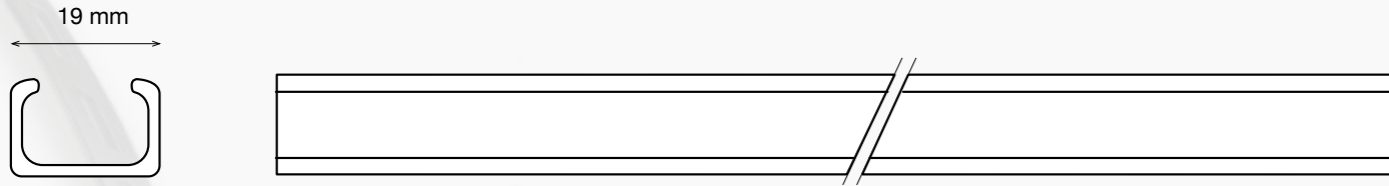

ART. PU008	Lungh. nastro Tape length	Codice Lamiflex Lamiflex Code	Lungh. nastro Tape length	Codice Lamiflex Lamiflex Code
Telaio/Loom DORNIER PTV	1050 mm	PU008 1050	1670 mm	PU008 1670
	1100 mm	PU008 1100	1700 mm	PU008 1700
	1120 mm	PU008 1120	1720 mm	PU008 1720
	1150 mm	PU008 1150	1750 mm	PU008 1750
	1170 mm	PU008 1170	1770 mm	PU008 1770
	1200 mm	PU008 1200	1820 mm	PU008 1820
	1220 mm	PU008 1220	1850 mm	PU008 1850
	1250 mm	PU008 1250	1900 mm	PU008 1900
	1270 mm	PU008 1270	1920 mm	PU008 1920
	1300 mm	PU008 1300	1950 mm	PU008 1950
	1320 mm	PU008 1320	1970 mm	PU008 1970
	1350 mm	PU008 1350	2000 mm	PU008 2000
	1370 mm	PU008 1370	2020 mm	PU008 2020
	1400 mm	PU008 1400	2050 mm	PU008 2050
	1420 mm	PU008 1420	2070 mm	PU008 2070
	1450 mm	PU008 1450	2100 mm	PU008 2100
	1470 mm	PU008 1470	2120 mm	PU008 2120
	1500 mm	PU008 1500	2150 mm	PU008 2150
	1520 mm	PU008 1520	2200 mm	PU008 2200
	1550 mm	PU008 1550	2220 mm	PU008 2220
	1570 mm	PU008 1570	2320 mm	PU008 2320
	1600 mm	PU008 1600	2450 mm	PU008 2450
	1620 mm	PU008 1620	3400 mm	PU008 3400
	1650 mm	PU008 1650		

Mod. LAMIFLEX 044



Solo i nastri marchiati come nella riproduzione fotografica sono **Nastri Originali Lamiflex**. Il marchio d'eccellenza **STARX** garantisce l'utilizzo dei materiali più innovativi ad alta resistenza.

Only the tapes marked as mentioned in this photograph are **Original Lamiflex Tapes**. The **STARX** excellence trade-mark certifies the use of the best and innovative materials with high resistance.

I NOSTRI PARTNER NELLA DISTRIBUZIONE OUR DISTRIBUTION PARTNERS



- | | | | |
|--------|--------|--------|-----------|
| Europe | China | Iran | Indonesia |
| Brazil | Japan | Syria | Pakistan |
| U.S.A. | Taiwan | Turkey | Vietnam |
| Mexico | Egypt | India | Korea |



ALTA TECNOLOGIA DEI COMPOSITI

LAMIFLEX SPA

24028 Ponte Nossa (BG) Italy - Via E. De Angeli, 51
Tel. +39 035 70 00 11 - Fax +39 035 70 00 60
info@lamiflex.it - www.lamiflex.it



LAMIFLEX - ASIA LTD.

Unit 3, Block C, 7/F. - Cheong Wah Factory Bldg.
39-41 Sheung Heung Road - Kowloon - HONGKONG
Phone (852) 27 66 28 38 - Fax (852) 27 66 283
info@lamiflex-asia.com.hk - www.lamiflex-asia.com.hk

Mod. LAMIFLEX 044

img@itali.com