



PTDM55 TRADING AND IMPORT EXPORT COMPANY LIMITED



PTDM55 TRADING AND IMPORT EXPORT COMPANY LIMITED

ADD: NO, 2/2 LANE, TRUNG TAM THUC NGHIEM RAU QUA , TRAU QUY TOWN,
GIA LAM DISTRICTS, HA NOI CITY
TEL : +84(0243)8768460 | FAX: +84(0243).8760426
EMAIL: PHUTUNGDETMAY55@GMAIL.COM
WEBSITE :WWW.PHUTUNGDETMAY55.COM



OUR COMPANY

PTDM55 TRADING AND IMPORT EXPORT COMPANY LIMITED

ADD: NO, 2/2 LANE, TRUNG TAM THUC NGHIEM RAU QUA , TRAU QUY TOWN, GIA LAM DISTRICTS, HA NOI CITY
TEL : +84(0243)8768460 | FAX: +84(0243).8760426
EMAIL: PHUTUNGDETMAY55@GMAIL.COM
WEBSITE :WWW.PHUTUNGDETMAY55.COM

Phụ Tùng Dệt May 55 xin gửi lời chúc tới Quý Doanh Nghiệp luôn gặt hái nhiều thành công và không ngừng phát triển.

Kính thưa: Quý Doanh Nghiệp

Phụ Tùng Dệt May 55 hoạt động từ năm 2009 trong các lĩnh vực kinh doanh và phân phối các sản phẩm về phụ tùng ngành sợi, dệt, tẩm nhuộm, định hình hoàn tất, máy cho ngành công nghiệp. Là một trong những nhà đại diện cho các nhãn hiệu nổi tiếng trong nước và quốc tế Ý, Mỹ, Pháp, Nhật Bản, Đài Loan, Hàn Quốc ... Hiện tại Phụ Tùng Dệt May 55 chúng tôi đã và đang cung cấp cho các Công ty, Xí nghiệp tại các tỉnh thành TP. Hà Nội, Bắc Ninh, Hưng Yên, Hải Dương, Hải Phòng, Thái Bình, Nam Định, Vĩnh Phúc, Thanh Hóa, Nghệ An, Đà Nẵng, TP. Hồ Chí Minh các tỉnh thành lân cận thuộc Ngành dệt, may, văng sấy, tẩm nhuộm...

CÁC MẶT HÀNG CHÚNG TÔI CUNG CẤP GỒM:

- Nhập khẩu các loại máy, phụ tùng linh kiện thay thế chính hãng máy dệt kiểm, dệt khi, dệt nước, dệt thoi. Phục vụ dệt khăn mặt, dệt vải, dệt nhãn mác, băng dây đai thuộc các hãng Vamatex, Picanol, Dornier, Nissan, Toyota, Sulzer, Tsudakoma, Somet, Muller ...
 - Nhập khẩu Các loại máy dệt thun bản của các hãng Đài Loan DKY, Trung Quốc.
 - Nhập khẩu phụ tùng, máy sợi con, máy sợi thô, máy chải, máy cọc, OE.
 - Nhập khẩu máy văng sấy, kim văng, má kẹp, rùa, xích tải, máy nhuộm. Máy sấy rung, máy hồ sợi, máy mắc, máy vắt công nghiệp.
 - Nhập khẩu máy cắt laser, cắt tem nhãn, máy in nhãn.
 - Gia công lắp đặt máy dệt, lắp ráp go xà máy dệt đầu Jacquard Staubli, Bonas, Gross, Muller, các dạng đầu máy dệt thun đai.
- Với đội ngũ cán bộ nhân viên chuyên nghiệp năng động, nhiệt tình, giao hàng nhanh chóng hiệu quả, cùng lợi thế cạnh tranh về giá, ưu đãi về dịch vụ, Chúng tôi rất mong được trở thành một đối tác đáng tin cậy của Quý Doanh nghiệp.

Garment spare parts trade and import export Co.,Ltd company PTDM 55 would like to send our best wishes to you for success. and continuous development.

Dear: Your Company

Textile and garment PTDM 55 has been operating since 2009 in the fields of trading and distribution of textile accessories, textile, dyeing, finishing and sewing for the industry. Be one of the elected representatives for many famous brands in Italy and the United States, the United States, Italia, France, Japan, Korea, China, Taiwan... At present, PTDM 55 garment spare parts have been supplied to factories in Ha Noi, Bac Ninh, Hung Yen, Hai Duong, Hai Phong, Thai Binh, Nam Dinh, Vinh Phuc, Thanh Hoa. , Nghe An, Da Nang, Ho Chi Minh City neighboring provinces of textile, garment, lacquer, dye ...

THE ITEMS WE OFFER INCLUDE:

- Importing machines, spare parts, genuine spare parts, weaving machines, Weaving face towel, weaving belts of Vamatex, Toyota, Sulzer, Tsudakoma, Somet, Muller...
- Importing textile Machines of Taiwanese firms DKY, China.
- Importing spare parts, spinning machine, coarse machine, brush machine, pile machine, OE.
- Importing stenter, stapler, chopper, turtle, chain, dyeing machine. Vibrating machine, spinning machine, hook machine, industrial crushers.
- Importing laser cutting machine, cutting stamp label, label printer.
- Fabrication of knitting machines, assembly of Jacquard Staubli, Bonas, Gross, Muller weaving machines, belt type weaving machines.

We have at our disposal a complete range of accessories and spare parts. High quality of distributed trade marks made of us as an example of textile industry a wide assortment of items and the timeliness of spare parts deliveries made of us great esteem of our customers.





OUR COMPANY

PTDM55 TRADING AND IMPORT EXPORT COMPANY LIMITED

ADD: NO, 2/2 LANE, TRUNG TAM THUC NGHIEM RAU QUA , TRAU QUY TOWN, GIA LAM DISTRICTS, HA NOI CITY

TEL : +84(0243)8768460 | FAX: +84(0243).8760426

EMAIL: PHUTUNGDETMAY55@GMAIL.COM

WEBSITE :WWW.PHUTUNGDETMAY55.COM



PTDM55-10



Pin-clip, clip, pin holder, chain, pin plate and graphite
Stenter brand: BACOCK Stenter, Ichikin Stenter, FAMATEX Stenter



PTDM55-12



Pin-clip, clip and chain
Stenter brand: TEXIMA Stenter

PTDM55-11



Clip and chain
Stenter brand: Harish Stenter

PTDM55-20



PTDM55-20



Pin-clip, clip, pin holder, chain and pin plate **Stenter**
brand: ARTOS Stenter

PTDM55-25

Clip and chain
Stenter brand:
 Tung Yang Wakayama



PTDM55-30



PTDM55-30



PTDM55-30



Pin-clip, clip, pin holder, chain, pin plate, graphite and nonlubricant railway
Stenter brand: MONFORTS Stenter
 Shaoyang stenter 774, M5466, M5468, M5469, LMR432, Shanghai stenter 797 and 798,
 Xinchang stenter ZLMD 991, Wuxi stenter ASMA 503

PTDM55-40



Pin-clip, clip, pin holder, chain, pin plate and graphite
Stenter brand: BRUCKNER Stenter

PTDM55-45



Clip
Stenter brand: BRUCKNER Stenter

PTDM55-50



Plip, clip, pin holder, chain and pin plate
Stenter brand: VICTEX Stenter

PTDM55-60



PTDM55-60

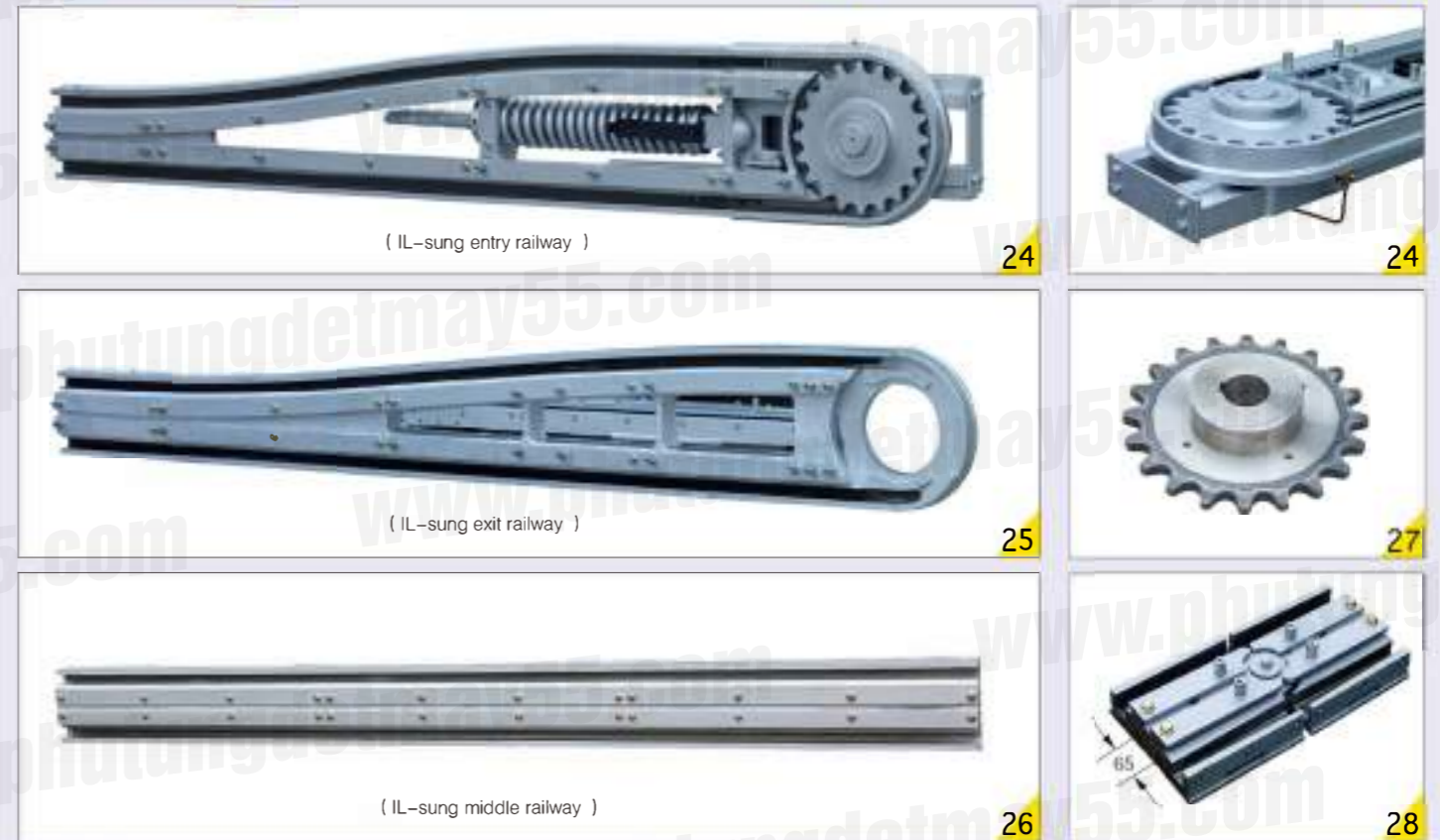

PTDM55-60

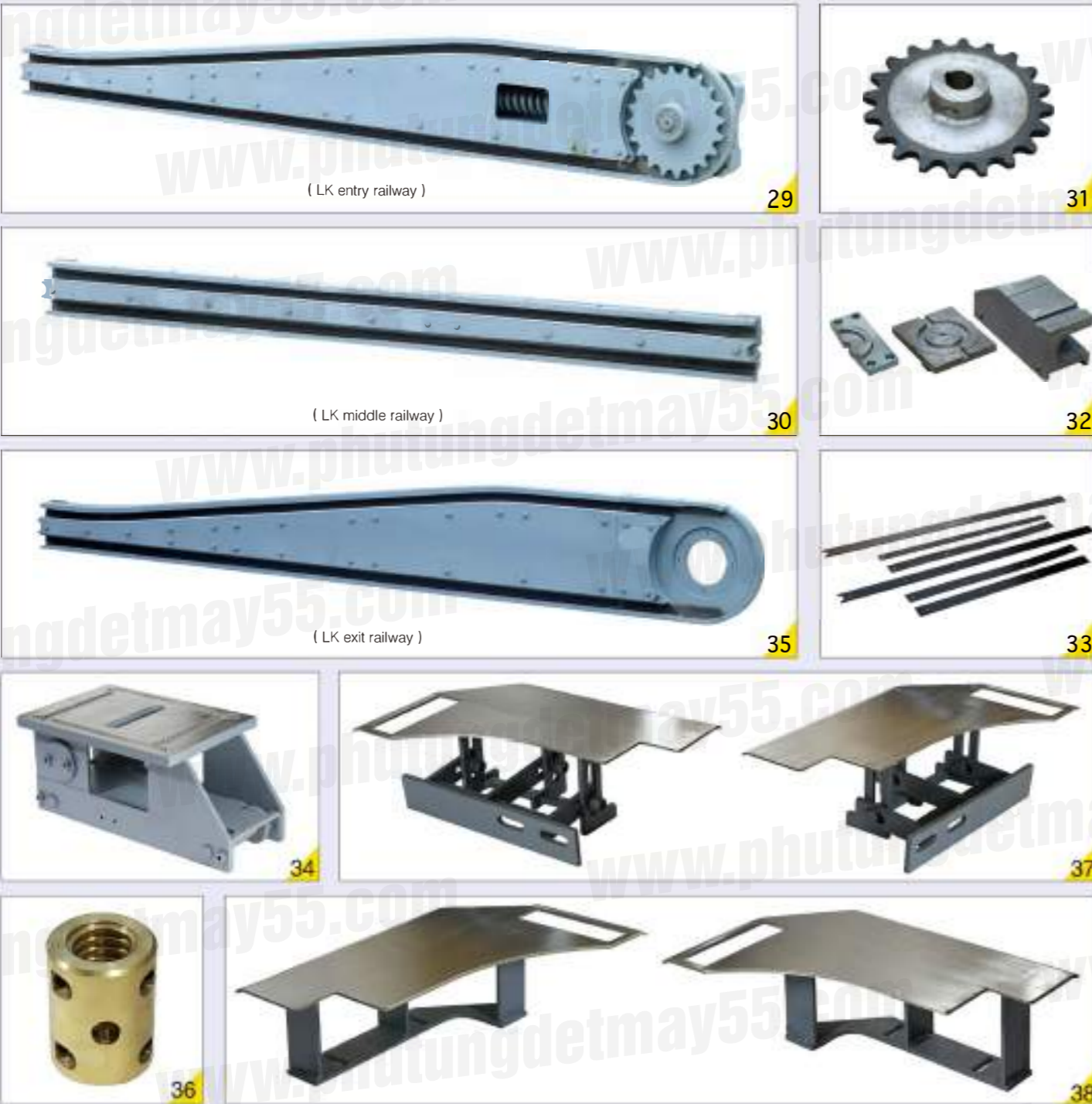

SAMILL

Pin-clip, clip, pin holder, chain, pin plate and rail lubricating board

Stenter brand: Taiwan LK&LH Stenter, Korea IL SUNG, EHWHA, HIRANO, MEGATEX, SAMILL Stenter

PTDM55-60



PTDM55-70



Pin-clip, clip, pin holder, chain and pin plate
Stenter brand: AMDES Stenter

PTDM55-80



PTDM55-80



Pin-clip, clip, pin holder, chain, pin plate and railway
Stenter brand: Japan Wakayama Stenter

PTDM55-100



Plip, pin holder and chain
Stenter brand: Japan SUZUKI Stenter

PTDM55-90



Pin-clip, clip, pin holder, chain and pin plate
Stenter brand: SANTALUCIA Stenter

PTDM55-110



TM48 pin-clip, clip, pin holder, TM47 chain, 701 chain and pin plate
Stenter brand: China-made LM734 Stenter, ZH921 Stenter

PTDM55-120



MT501 pin-clip, clip, pin holder, MT516 chain and pin plate
Stenter brand: China-made Hot Air Stenter, Shaoyang stenter M5466



PTDM55-130

Plip, chain and pin holder
Stenter brand: ALEA Stenter



PTDM55-140



PTDM55-140

Clip, chain and pin plate
Stenter brand: KRANTZ Stenter



PTDM55-150

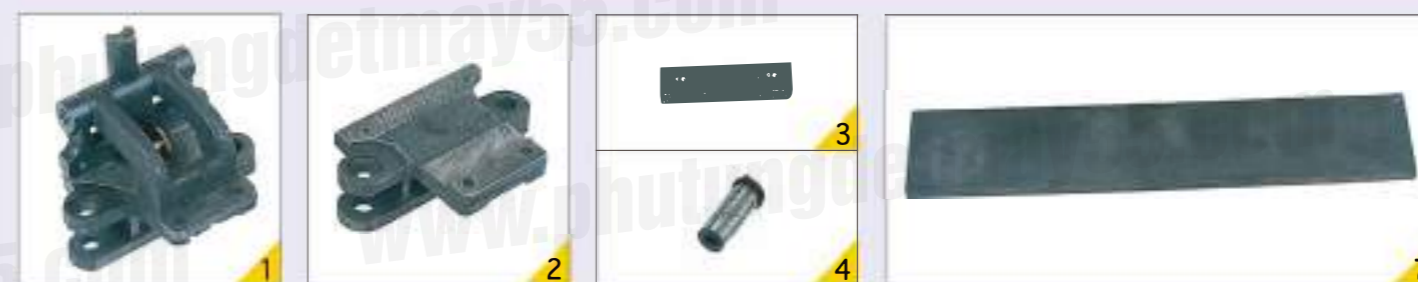

Plip, chain and rail lubricating board
Stenter brand: 50-301 Mercerizing Stentering Range



PTDM55-160



Plip, chain and lubricating board
Stenter brand: 50-303 Mercerizing Stentering Range (High Speed Mercerizing Machine)



PTDM55-170



Clip and chain
Stenter brand: K44B Mercerizing Stentering Range

PTDM55-170-II

Clip and chain
Stenter brand: K44B Mercerizing Machine



PTDM55-180 - 1

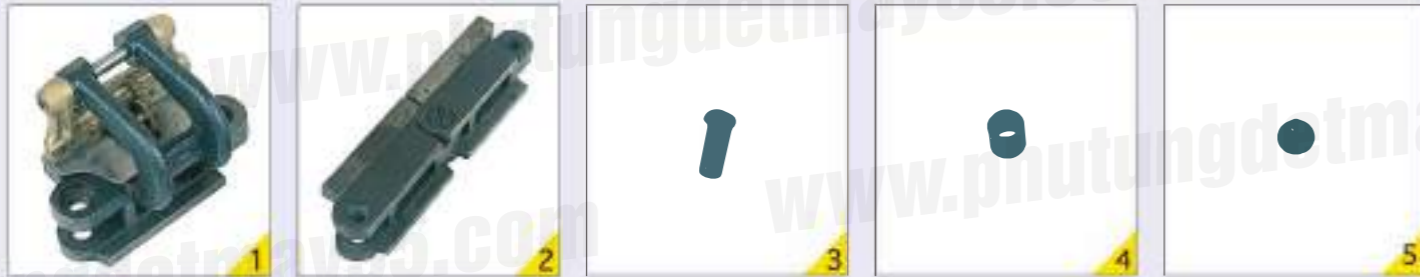

Clip, pin holder and chain
Stenter brand: KCK Mercerizing Stentering Range

PTDM55-180 -2

Clip and chain
Stenter brand: KCK Stenter, KCK Mercerizing Stentering Range



PTDM55-190-1

Mercerizing clip and chain
Stenter brand: Japan Sando Machine



PTDM55-190-2

Mercerizing clip
Stenter brand: Japan Wakayama Mercerizing Machine



PTDM55-190型-3



Mercerizing clip and chain
Mercerizing machine brand: Japan Wakayama Mercerizing Machine

PTDM55-190-3 II

Mercerizing clip, chain, pin holder and pin plate
Mercerizing machine brand: Japan Wakayama Mercerizing Machine



PTDM55-190-4

Mercerizing clip and chain
Mercerizing machine brand: Japan Wakayama Mercerizing Machine



PTDM55-190 -5

Mergerizing clip and chain
Mergerizing machine brand:
 Wakayama Mergerizing Machine



PTDM55-210



Clip, pin holder and pin plate
Stenter brand: Stentex Stenter



PTDM55-220

Clip and pin holder
Stenter brand: Italy Stenter



PTDM55-230

Clip and chain
Stenter brand: Japan Oxford Stenter



PTDM55-240



Chain and pin holder
Stenter brand: 452 Heat Stenter

PTDM55-280

Screen tenter machine clip
Brand: Screen Tenter Machine



PTDM55-290

Cloth gripper



PTDM55-300

Chain
Stenter brand: 722 Stenter



PTDM55-310



PTDM55 -310



Chain, cloth roll, linked arm and stopper
Brand: Italy Arioli Ager

PTDM55 -330



Chain
Brand: Oxygen Bleaching Range

PTDM55 -340



Chain
Brand: Dryer machine

PTDM55 -341



Chain, pin plate
Brand: Dryer machine

PTDM55 -342



Clip, chain
Brand: Dryer machine

PTDM55 -500



Vertical chain, pin holder, cloth gripper and pin plate
Stenter brand: BABCOCK Stenter



PTDM55 -500 - II

Vertical chain
Stenter brand: BABCOCK Stenter



PTDM55 -511

Vertical chain, pin holder, cloth gripper and pin plate
Stenter brand: BRUCKNER Stenter



PTDM55-510



Vertical chain, pin holder, cloth gripper and pin plate
Stenter brand: BRUCKNER Stenter

PTDM55-520



Vertical chain, pin holder and pin plate
Stenter brand: BRUCKNER Stenter

PTDM55-530

Vertical chain, pin holder and pin plate
Stenter brand: MONFORTS Knitting Stenter



PTDM55-540



Vertical chain, pin holder, pin plate, sliding piece, PEEK block, railway and graphite
Stenter brand: KRANTZ Stenter

PTDM55-550



Vertical chain, pin holder and pin plate
Stenter brand: Italy Lafer compact machine

PTDM55-560

Vertical chain and pin holder
Stenter brand: Italy Knitting Stenter



PTDM55-570



Vertical chain, pin holder and pin plate
Compact machine brand: Stentex Compact Machine

PTDM55-580



Vertical chain, pin holder and pin plate
Compact machine brand: Italy Ferraro Compact Machine

PTDM55-590



Vertical chain, pin holder and pin plate
Stenter brand: Italy Unitech Stenter

PTDM55-600



PTDM55-600

Vertical chain, pin holder and pin plate
Carpet machine brand: SANTALUCIA Carpet Machine

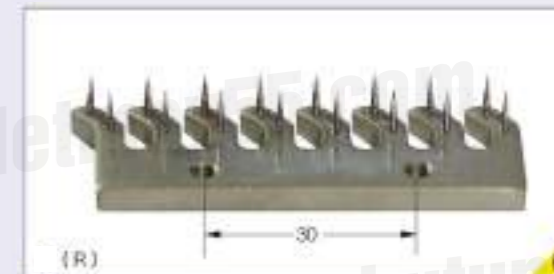

PTDM55-610

Vertical chain, pin holder and pin plate
Carpet machine brand: Japan Carpet Machine



PTDM55-610-II



Vertical chain, pin holder and pin plate
Carpet machine brand: Japan Carpet Machine

PTDM55-610-IV

Vertical chain and pin holder
Carpet machine brand: Japan Carpet Machine



PTDM55-700

Vertical chain and pin holder
Stenter brand: 642 Heat Stenter



PTDM55-701

Vertical chain and pin holder **Brand:** Coating Machine



PTDM55-710

Vertical chain and pin holder
Brand: Coating Machine



PTDM55-720

Vertical chain and pin holder
Brand: Coating Machine



PTDM55-720 - II

Vertical chain and pin holder



PTDM55-730

Vertical chain and pin holder
Brand: Coating Machine



PTDM55-750



Vertical chain, pin holder and pin plate
 Mercerizing machine brand: Benniger Mercerizing Stentering Range

PTDM55-800

Nylon chain and pin holder



PTDM55-820

Type XTY-820 vertical chain and pin holder **Stenter brand:** Vertical TEXIMA Stenter



PTDM55-6191/6192

Clip and chain
Stenter brand: Geotextile Stenter



PTDM55-900

Various pin plates for stenters



PTDM55-910

Bushing and sliding pieces



PTDM55-950

Various rail lubricating boards and guide boards for stenter

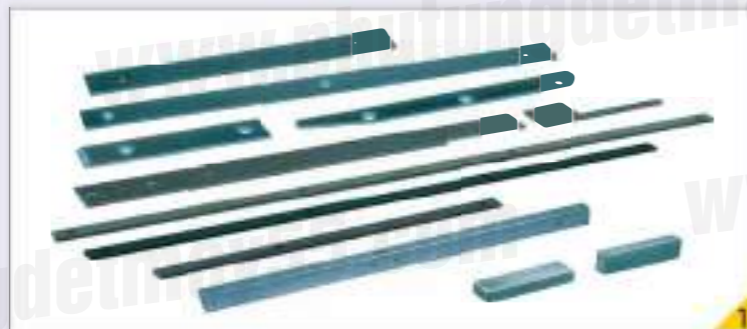

PTDM55-960



(LK)
φ 200 × φ 80 × 20



(LK)
φ 200 × φ 70 × 20



φ 200 × φ 140 × 25



φ 180 × φ 123 × 21.5



(Monforts)
φ 220 × φ 169 × 20



(Monforts)
φ 220 × φ 165 × 21



(Monforts)
φ 182 × φ 23 × 26



(Chengfn)
φ 182 × φ 72 × 22



φ 250 × φ 140 × 22



φ 204 × φ 144 × 25



(Bobcock)
φ 267 × φ 210 × 22



(Eruckner)
φ 162 × φ 88 × 16



(Artos)
φ 205 × φ 145 × 17



(Wakayama)
φ 262 × φ 80 × 22



(IL-Sung)
φ 220 × φ 190 × 75

Various brush wheels for stenter

PTDM55-970



Gummy cutting and suction device



PTDM55-980



Various pin wheels for stenter

PTDM55-990

Various cloth knives for stenter



(PTDM55-TZGZ-737)

High Temperature Grease

BARRIERTA L 55/0-3 series long-term greases offer excellent resistance to high temperature and aggressive media and at the same time compatibility with plastics and elastomers.

Product Parameters

Parameters	L55/2-TZGZ-737	
Base oil	PFPE	
Thickener	PTFE	
Surface Appearance	milk white	
Standard NLGI Level	2	
Penetration	265 ~ 295	
(°C) Temperature	-30 ~ 260	
(g/cm ³ 20°C) Density	1.93	
Base Oil Viscosity (mm ² /s)	40°C	407
	100°C	35
Warranty (original sealed)	60 months	



Imported Lubricating Grease



PTDM55-8100



Four fingers selvedge uncurler



PTDM55-8100



Selvedge uncurler detecting holder

PTDM55-8300



Three fingers selvedge uncurler

PTDM55-8500 - 2



Flat Nylon selvedge uncurler



(With detecting holder)

PTDM55-8500 - 3



Flat nylon selvedge uncurler

PTDM55-8700



Flat nylon selvedge uncurler

PTDM55-8800



One side pneumatic selvedge uncurler

PTDM55-8900



Double sides pneumatic selvedge uncurler

PTDM55-9200-2



Different types of supporting wheels

PTDM55-9200-5



Passive brushing device

PTDM55-9200-10



Depinning device

PTDM55-9600-1



Pinning device

PTDM55-9600-7



Pinning device

PTDM55-9900



Pin plate cleaning device



Dust collector of Pin plate cleaning device



Installation bracket

Cloth guiders



PN2 Type Pneumatic Cloth Guider

It is used under pressure less than 3 kg/cubic cm to compress air. It is mainly used in the printing&dyeing industry to prevent from deviation during fabric motions. It helps stretching the fabrics without wrinkle.



DX80-2 Type Photoelectric Cloth Guider

It is mainly used in the printing&dyeing industry to prevent from deviation during fabric motions. It helps stretching the fabrics without wrinkle. It has long life, stable working and high sensitiveness.

PTDM55-7000

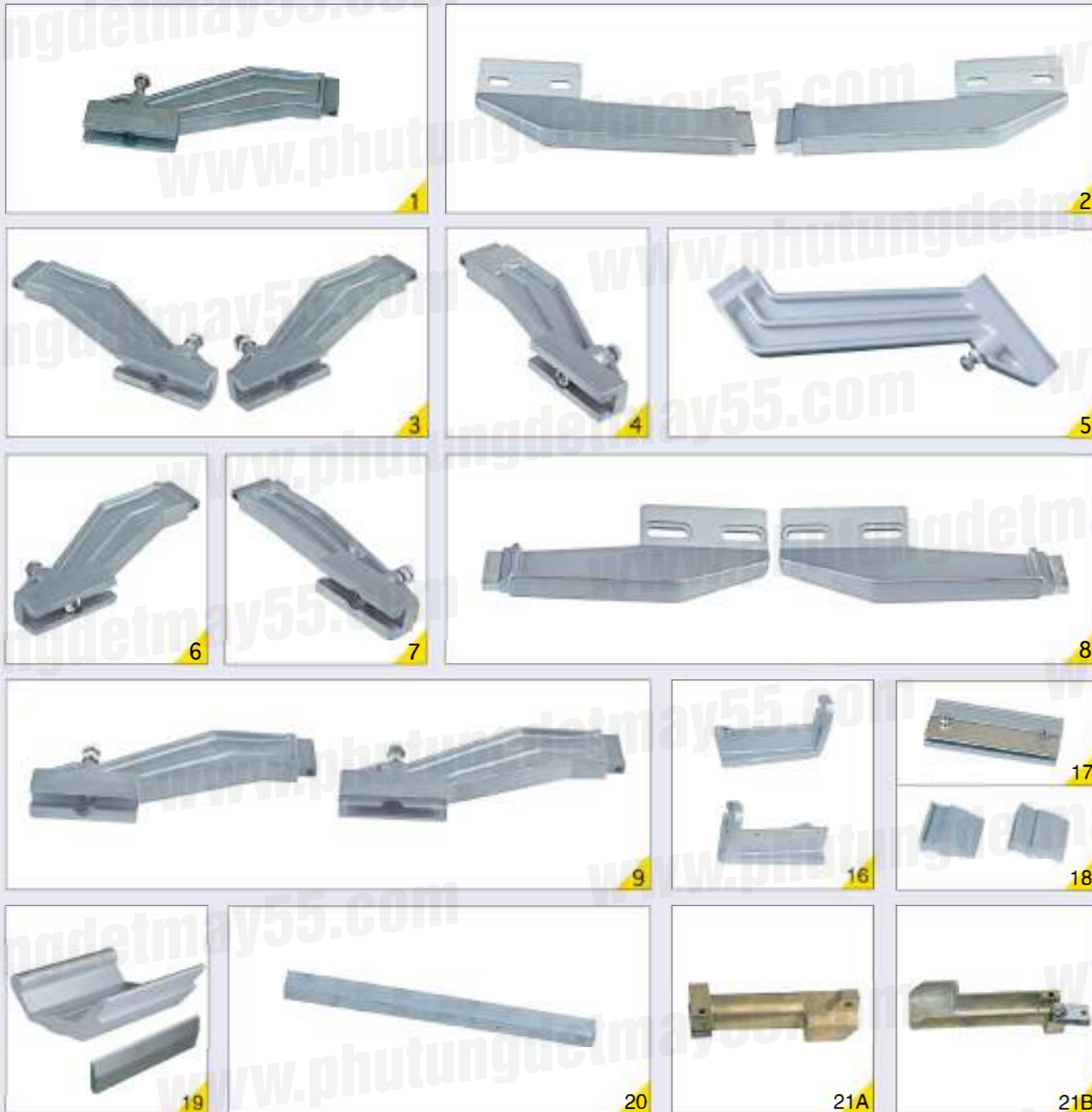

Flat screen printing machine doctor and doctor bracket
Printing machine brand: Japan Flat Screen Printing Machine

PTDM55-7000



(Doctor bracket types)

(mm) (Unit)	I	II (L/R)	III (L/R)	IV	V	VI	VII	VIII (L/R)
A	149	147	149	118	296	133	102	136.5
B	300	393	300	320	350	340	308	330

PTDM55-7100



Flat screen printing machine doctor and doctor bracket
Printing machine brand: Swiss HYDROMAG Flat Screen Printing Machine
 Italy VIERO Printing Machine

PTDM55-7200

Flat screen printing machine doctor and doctor bracket
Printing machine brand: Italy ACIMIT Flat Screen Printing Machine



PTDM55-7300



Flat screen printing machine doctor and doctor bracket
Printing machine brand: Qizheng Flat Screen Printing Machine



PTDM55-7500

Flat screen printing machine doctor and doctor bracket
Printing machine brand: Qizheng Flat Screen Printing Machine



PTDM55-7700



Various flat screen printing machine doctor blades

XTY-7900-1



640 end ring
Printing machine brand: Rotary Screen Printing Machine



PTDM55-7900-2

820 end ring
Printing machine brand: Rotary Screen Printing Machine



PTDM55-7900-3

914 end ring
Printing machine brand: Rotary Screen Printing Machine



PTDM55-7900-4

1018 end ring
Printing machine brand: Rotary Screen Printing Machine



TM-W



TM-W Centering Device



Centering Device

Main Characteristics:

- Two rollers can rotate 360 degrees, in order to adjust the angle of different fabric scrolls.
- The spreading rollers can be equipped as per the requirement, so as to be suitable for various fabrics.
- Inspection and controlling system with the characteristic of sensitivity and stability.
- Driving structure uses the special engineering plastic and stainless steel gear, which has high efficient driving effect, low noise and energy saving effect.
- With the manual and automatic operating mode.

Technical Data:

- Roller Width (mm) : W (small width 1600~2600, big width 2800~3600)
- Fabric Width (mm) : W-200
- Maximum Fabric Feed Speed: 120m/min
- Air Supply Pressure: 0.4~0.6MPa
- Ambient Temperature: ≤40℃
- Power Supply Voltage: 380V

Chamber features



Chamber features

Modular design

4-10 chambers, 3 meter each, with air seals at both the entry and the exit of the chambers; One set of heating device equipped in each chamber (using heating oil, vapor or fuel gas as the heat source), with individual temperature control; The structure can warm fast and is easy to assemble, increasing the assembly speed at user site; Chamber insulation board is 150mm thick, of good heat preservation and energy saving; Heat source pipe is going through the chamber top, making the whole chamber of simple style; The frame is made by section steel and cold rolling steel is used in the insulated door; The panel is with spraying coating treatment; The surface appearance is nice.

Technical parameters:

Nominal width (w) : 1800、2000、2200、2400、2600 (narrow type)
 2800、3000、3200、3400、3600 (wide type)
 Fabric processing width range: 900 ~ (w-200)
 Speed range: 10 ~100 m/min
 Working temperature: ≤ 220 °C

Chamber features

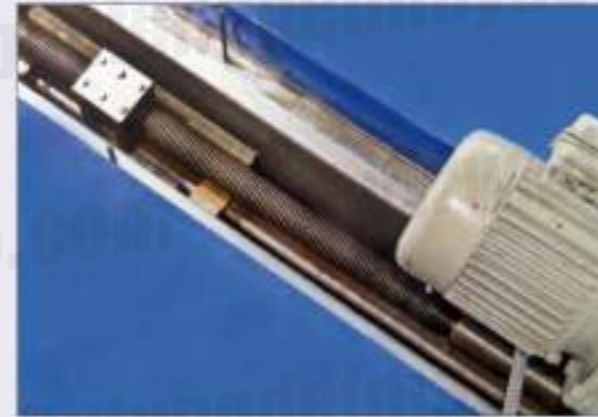

Reasonable Width Adjustment System, Running Reliably

An individual adjusted screw rod driven by motor is used every 3 meter inside the chambers;
 Users can set fabric width conveniently, with width limit and angle limit for protection;
 Squeeze screw rod is used to lengthen the lift time.



Specially Designed Hot Air Circulation System

Efficient and energy saving double air duct hot air circulation system is used in the chambers;
 The airflow up and down can be set any ratio needed, which is controlled by the air door;
 The specially designed nozzle system can ensure good setting effect and get reasonable shrinkage rate;
 Circulation fans motor is designed with temperature resistance and imported bearing equipped, which lengthen the lift time of circulation fans motor.

Easy for Maintenance and Cleaning

All the connection parts of the chambers and the chamber door plate are sealed by the well-designed silicone rubber seals, which can be assembled and disassembled conveniently;
 There equipped a small insulation door on the adjustment position of every chamber top, easy for the system's cleaning and maintenance;
 The bearing of screw rod and circulation fan can be greased outside the chamber very conveniently;
 Double layers of filtering screens are set in every chamber, doing the cleaning without stopping the machine;
 The back punching is used in the hot air duct, avoiding the fabric extrusion.

